

INDUSTRIAL CONTROL ELECTRIC

» *Always for your safety*



Always for your safety



RoHS

COMPANY INTRODUCTION

Zhejiang ETEK Electrical Technology Co., Ltd. (Abbreviation: ETEK Electric) is a professional manufacturing company dedicated to the research, development, production, and sales of low-voltage electrical appliances. The company was established in 2011 and is located in Wenzhou City, Zhejiang Province. At present, the company has 40K sqm of modern manufacturing bases in Wenzhou and Wuhu with over 500 employees, including over 50 R&D and technical personnel. ETEK Electric has multiple production workshops for mold design, parts manufacturing, welding, and assembly. Additionally, they have multiple automated production lines for MCB and RCCB. Our products include MCB, RCCB, RCBO, AFDD, MCCB, ACB, EV Chargers, Photovoltaic DC products, etc., which can meet the needs of different countries and are widely used in fields such as residential, commercial, and industrial.

ETEK Electric has passed ISO9001 quality management system and environmental management system certification. The company have built our own low-voltage electrical testing center, and most of the testing items can meet the requirements of international IEC standards, in addition, our products have obtained international CB, TUV, VDE, CE, RoHS and other quality certificates.

ETEK Electric constantly masters and breaks through the core technology of circuit breakers, with more than 100 national patents. Focusing on independent brand construction is crucial for the company's development. The "ETEK" trademark is registered in over 80 countries. Products are exported to over 60 countries and regions including the European Union, South America, the Middle East, Africa, and Southeast Asia.

We also support OEM, ODM, OBM, SKD, CKD and other business cooperation models, and provide customers with a full range of services covering market cultivation, technical training, and factory construction.

ETEK Electric has been adhering to the business policy of "Growth", "Quality", "Efficiency", and "Innovation". In 2023, ETEK Electric has formulated the fifth 3-year strategic plan, which specifies the three major initiatives of expanding the production scale, enhancing the new energy market share, and expanding the independent brand, to realize the annual revenue target of \$50 million by 2026.

Looking forward to the future, ETEK Electric will be committed to becoming a globally renowned manufacturer in the power distribution and electrical industry, safeguarding the power safety of global customers, and helping the development of green and digital energy.



Wenzhou Factory



Wuhu Factory

WORKSHOPS



OEM & ODM BUSINESS

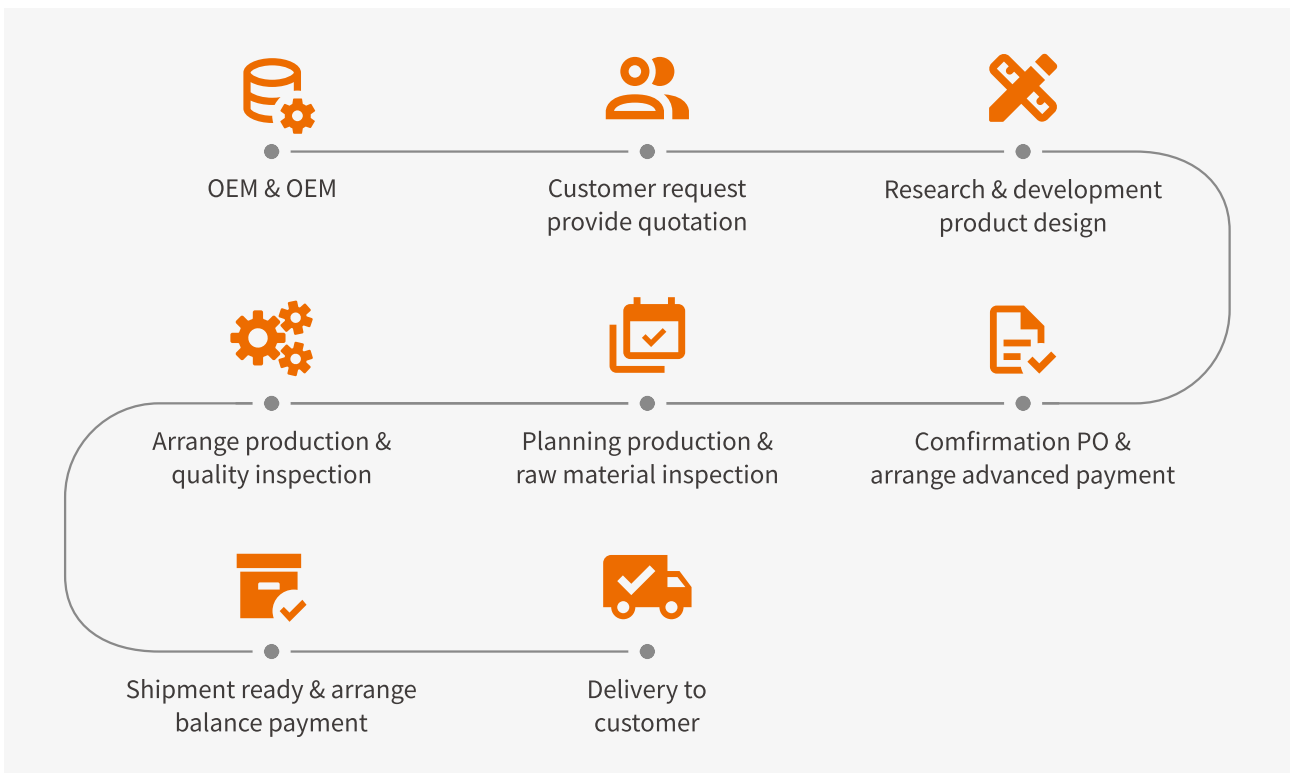

CONTENTS

EKC2 Contactor 9~95A	01
EKC2S Economic Type AC Contactor	04
EKC2W Wide Voltage Range Contactor	07
EKC2SU Built-in Surge Suppressors Contactor	10
EKC2F Contactor 115~2600A	13
EKC2-M Mini Contactor 6~12A	19
EKR2 Thermal Overload Relay	23
Contactor Accessories	27
EKQ1 DOL Electromagnetic Starter	29
EKQ2 DOL Electromagnetic Starter	31
EKMS2 MPCB Motor Protection Circuit Breaker	33
EKLD LED Indicator (Ø22mm)	36
EKLV22 LED Indicator With Voltage Meter (Ø22mm)	38
EKPB2 Pushbutton Switch (Ø22mm)	39
EKPBM Foot Pedal Switch	47
EKCB Control Box	49
EKCB Push Button Station Enclosure (Ø22mm)	51
EKRS26 Rotary Switch	53
EKIS30 Isolation Switch	61
EKIS30 Isolation Switch Waterproof Box	64
EKISP Isolation Switch Waterproof Box	65

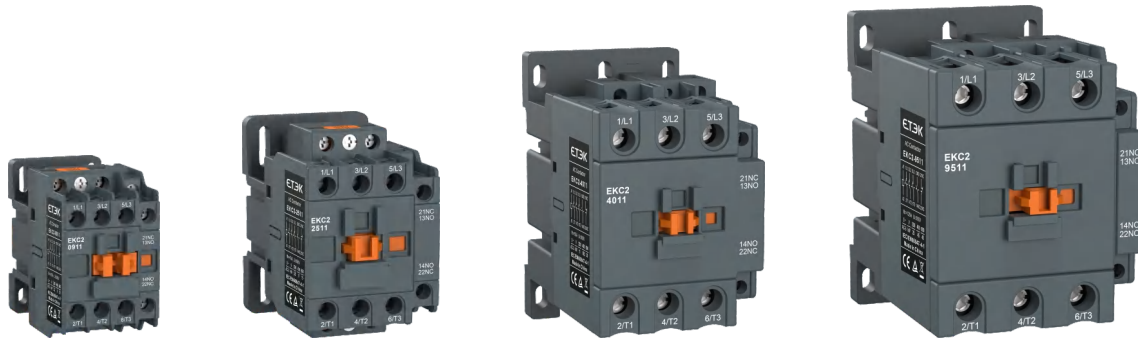

Product Overview

EKC2S series AC Contactor with novel appearance and compact structure is suitable for using starting & controlling the AC motor frequently, switching on and off the circuit at a long distance. It is used in combination with thermal relay to compose a magnetic motor starter.

Standard: IEC 60947-4-1.

Type Designation

EK	C	2	-	25	11	-	24V
↓	↓	↓		↓	↓		↓
①	②	③		④	⑤		⑥

Code	Meaning	Code	Meaning
①	Company code	④	Rated operational current (380V/400V, AC3): 9A,12A,18A,25A,32A,40A,50A,65A,80A,95A
②	Contactor	⑤	Number of contacts 11: 3NO main contacts+1NO and 1NC auxiliary contact
③	Design sequence NO.	⑥	Coil voltage: 24V,48V,110V,240V,415V

Operating and Installation Conditions

Type	Operating and Installation Conditions
Installation category	III
Pollution level	3
Certification	CE, CB, TUV
Protection degree	EKC2S-09~38: IP20; EKC2S-40~95: IP10
Ambient temperature	limit of temperature: -35°C~+70°C, normal temperature: -5°C~+40°C, The average no more than +35°C within 24 hours. If not in normal operating temperature range, please refer to "Instructions for abnormal environment"
Altitude	≤2000m
Ambient humidity	The maximum temperature of 70 degrees, the air relative humidity not exceed 50%, under lower temperature can allow for higher relative humidity. If the temperature is 20°C, the air relative humidity could up to 90%, Special measures should be taken for occasional condensation due to humidity changes.
Installation position	Inclination between installation surface and vertical surface should not exceed ±5°
Shock vibration	Products should be installed and used without significant shake, shock and vibration place.

Technical Data

Type		EKC2-09	EKC2-12	EKC2-18	EKC2-25	EKC2-32	EKC2-40	EKC2-50	EKC2-65	EKC2-80	EKC2-95	
Main circuit characteristic												
Poles		3P										
Main contact		3NO										
Rated insulation voltage(Ui)(V)		690V										
Rated operating voltage(Ue)(V)		380/400V; 660/690V										
Rated thermal current(Ith), AC-1		20	20	32	40	50	60	80	80	125	125	
Rated operation current(Ie)(A)	AC-3, 380/400V	9	12	18	25	32	40	50	65	80	95	
	AC-3, 660/690V	6.6	8.9	12	18	22	34	39	42	49	49	
	AC-4, 380/400V	3.5	5	7.7	8.5	12	18.5	24	28	37	44	
	AC-4, 660/690V	1.5	2	3.8	4.4	7.5	9	12	14	17.3	21.3	
Rated operational power(Pe)(A)	AC-3, 380/400V	4	5.5	7.5	11	15	18.5	22	30	37	45	
	AC-3, 660/690V	5.5	7.5	10	15	18.5	30	33	37	45	45	
	AC-4, 380/400V	1.5	2.2	3.3	4	5.4	7.5	11	15	18.5	22	
	AC-4, 660/690V	1.1	1.5	3	3.7	5.5	7.5	10	11	15	18.5	
Mechanical life($\times 10^3$ times)		1200			1000			900			650	
Electrical life($\times 10^3$ times)	AC-3	110				90				65		
	AC-4	22				22	17			11		
Frequency of operation (time/h)	AC-3	1200				600						
	AC-4	300				300						
Control circuit characteristics												
Rated control voltage(Us)	50Hz	24V,48V,110V,240V,415V										
	50/60Hz	24V,48V,110V,240V,415V										
Allowed control circuit voltage	Operation	(85%~110%)Us										
	Release	(20%~75%)Us										
Power consumption of coil	Actuation(VA)	60			70			200			200	
	Keep(VA)	6-9.5			6-9.5			15-20			15-20	
	Consumption(W)	1-3			1-3			6-10			6-10	
Connecting capability of main circuit terminal												
Flexible wire No terminal	1 wire(mm ²)	1~4			1.5~6			2.5~25			4~50	
	2 wire(mm ²)	1~4			1.5~6			2.5~16			4~25	
Flexible wire With terminals	1 wire(mm ²)	1~4			1~6			2.5~25			4~50	
	2 wire(mm ²)	1~2.5			1~4			2.5~10			4~16	
Hard wire No terminal	1 wire(mm ²)	1~4			1.5~6	1.5~10		2.5~25			4~50	
	2 wire(mm ²)	1~4			1.5~6			2.5~10			4~25	
Fastening torque (N.m)		1.2			1.8			5			9	
Auxiliary contacts												
Built-in auxiliary contact		1NO+1NC										
Rated thermal current (Ith)		10A										
Rated operating voltage (Ue)	AC	380V										
	DC	220V										
Rated control capacity	AC-15	360VA										
	DC-13	33W										

Electric Life Curves

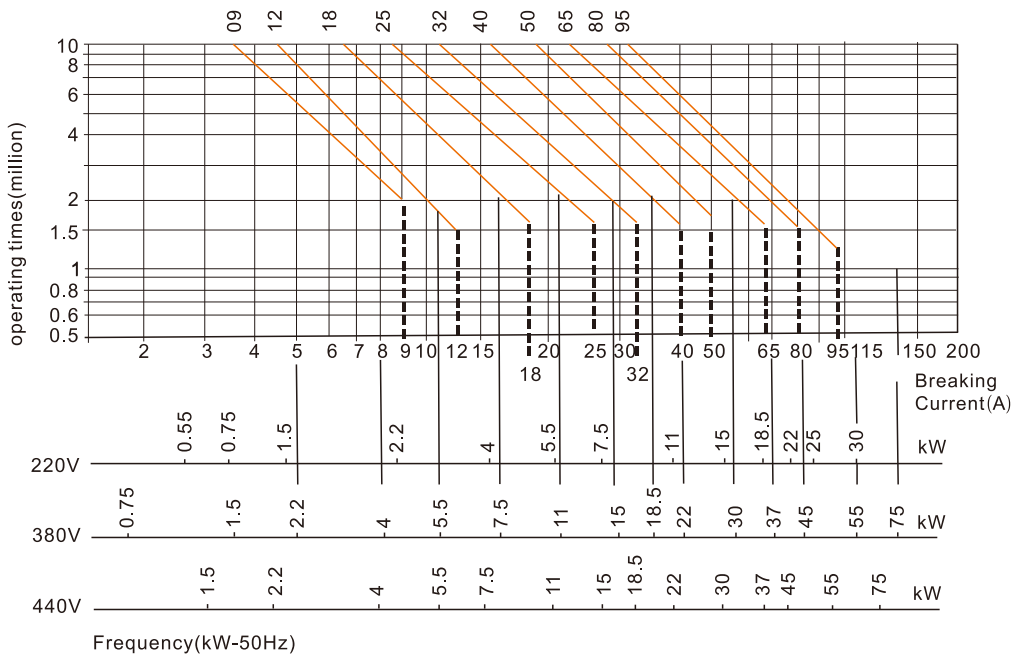

Dimension(mm)

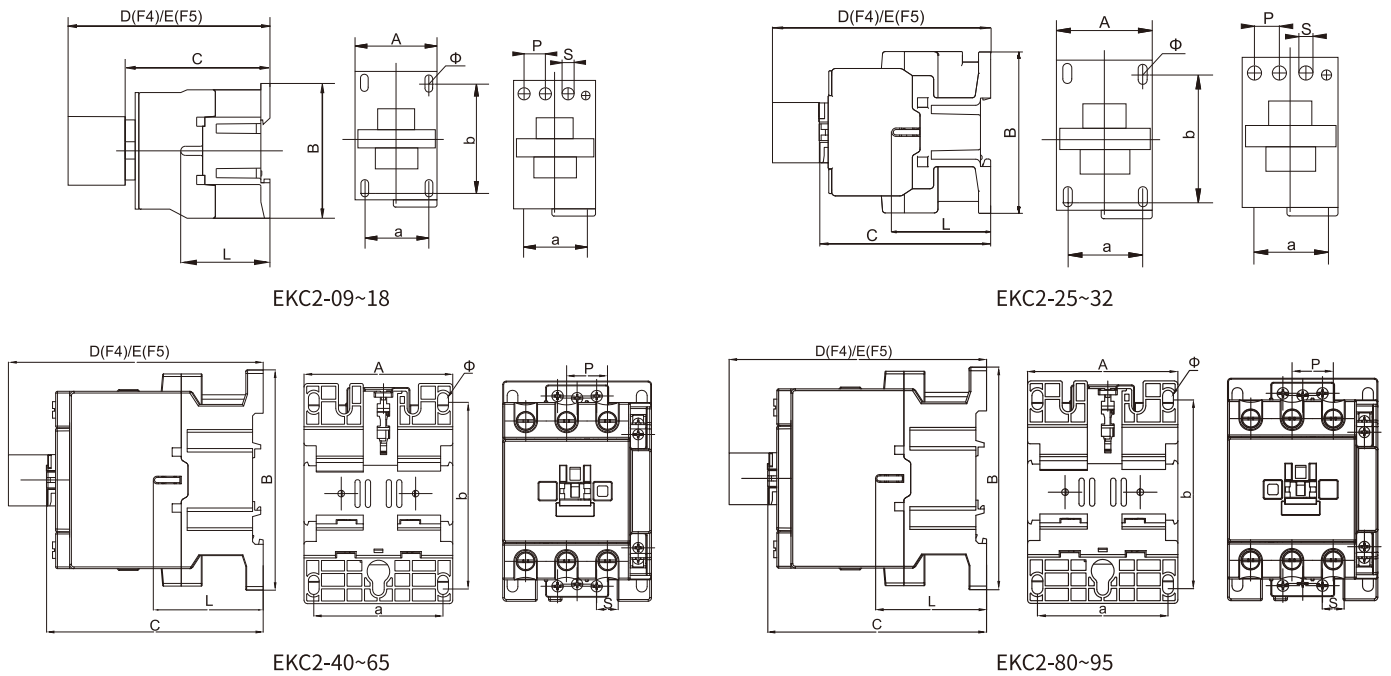

Model	A Max	B Max	C Max	D Max	E Max	a	b	ϕ	L	P	S
EKC2-09~18	45	74.5	87	120	124	34.5	50/60	4.5	51	11	10.5
EKC2-25~32	56	87	98.6	132	136	40	61.5	4.5	59.3	14.2	13
EKC2-40~65	75	127	118	151.1	155	63.5	105	6	63.2	20	14
EKC2-80~95	86	126.5	126.5	158.5	162.5	74.5	105	6	63.2	23.5	17.5



Product Overview

EKC2S series AC Contactor with novel appearance and compact structure is suitable for using starting & controlling the AC motor frequently, switching on and off the circuit at a long distance. It is used in combination with thermal relay to compose a magnetic motor starter. Standard: IEC 60947-4-1.

Type Designation

EK	C	2	S	-	25	11	-	24V
①	②	③	④		⑤	⑥		⑦

Code	Meaning
①	Company code
②	Contactor
③	Design sequence NO.
④	Economic type (small size)

Code	Meaning
⑤	Rated operational current (380V/400V, AC3): 9A,12A,18A,25A,32A,38,40A,50A,65A,80A,95A
⑥	Number of contacts 11: 3NO main contacts+1NO and 1NC auxiliary contact
⑦	Coil voltage: 24V,36V,48V,110V,127V,220/230V,240V, 380/400V,415V,440V

Operating and Installation Conditions

Type	Operating and Installation Conditions
Installation category	III
Pollution level	3
Certification	CE, CB, TUV
Protection degree	EKC2S-09~38: IP20; EKC2S-40~95: IP10
Ambient temperature	limit of temperature: -35°C~+70°C, normal temperature: -5°C~+40°C, The average no more than +35°C within 24 hours. If not in normal operating temperature range, please refer to "Instructions for abnormal environment"
Altitude	≤2000m
Ambient humidity	The maximum temperature of 70 degrees, the air relative humidity not exceed 50%, under lower temperature can allow for higher relative humidity. If the temperature is 20°C, the air relative humidity could up to 90%, Special measures should be taken for occasional condensation due to humidity changes.
Installation position	Inclination between installation surface and vertical surface should not exceed ±5°
Shock vibration	Products should be installed and used without significant shake, shock and vibration place.

Technical Data

Type	EKC2S-09	EKC2S-12	EKC2S-18	EKC2S-25	EKC2S-32	EKC2S-38	EKC2S-40	EKC2S-50	EKC2S-65	EKC2S-80	EKC2S-95			
Main circuit characteristic														
Poles	3P													
Main contact	3NO													
Rated insulation voltage(Ui)(V)	690V													
Rated operating voltage(Ue)(V)	380/400V; 660/690V													
Rated thermal current(Ith), AC-1	20	20	32	40	50	50	60	80	80	125	125			
Rated operation current(Ie)(A)	AC-3, 380/400V	9	12	18	25	32	38	40	50	65	80	95		
	AC-3, 660/690V	6.6	8.9	12	18	22	22	34	39	42	49	49		
	AC-4, 380/400V	3.5	5	7.7	8.5	12	14	18.5	24	28	37	44		
	AC-4, 660/690V	1.5	2	3.8	4.4	7.5	8.9	9	12	14	17.3	21.3		
Rated operational power(Pe)(A)	AC-3, 380/400V	4	5.5	7.5	11	15	18.5	18.5	22	30	37	45		
	AC-3, 660/690V	5.5	7.5	10	15	18.5	18.5	30	33	37	45	45		
	AC-4, 380/400V	1.5	2.2	3.3	4	5.4	5.5	7.5	11	15	18.5	22		
	AC-4, 660/690V	1.1	1.5	3	3.7	5.5	6	7.5	10	11	15	18.5		
Mechanical life($\times 10^3$ times)	1200			1000			900			650				
Electrical life($\times 10^3$ times)	AC-3	110				90				65				
	AC-4	22				22				17				
Frequency of operation (time/h)	AC-3	1200				600				300				
	AC-4	300				300				300				
Control circuit characteristics														
Rated control voltage(Us)	50Hz	24V,36V,48V,110V,127V,220/230V,240V, 380/400V,415V,440V												
	50/60Hz	24V,36V,48V,110V,127V,220/230V,240V, 380/400V,415V,440V												
Allowed control circuit voltage	Operation	Installation inclination angle $\pm 22.5^\circ$: 85%~110%Us; Installation inclination angle $\pm 5^\circ$: 70%~120%												
	Release	Installation inclination angle $\pm 22.5^\circ$: 20%~75%Us; Installation inclination angle $\pm 5^\circ$: 20%~65%												
Power consumption of coil	Actuation(VA)	60			70			200			200			
	Keep(VA)	6-9.5			6-9.5			15-20			15-20			
	Consumption(W)	1-3			1-3			6-10			6-10			
Connecting capability of main circuit terminal														
Flexible wire No terminal	1 wire(mm ²)	1~4			1.5~6			2.5~25			4~50			
	2 wire(mm ²)	1~4			1.5~6			2.5~16			4~25			
Flexible wire With terminals	1 wire(mm ²)	1~4			1~6			2.5~25			4~50			
	2 wire(mm ²)	1~2.5			1~4			2.5~10			4~16			
Hard wire No terminal	1 wire(mm ²)	1~4			1.5~6	1.5~10			2.5~25			4~50		
	2 wire(mm ²)	1~4			1.5~6			2.5~10			4~25			
Fastening torque (N.m)	1.2			1.8			5			9				
Auxiliary contacts														
Built-in auxiliary contact	1NO+1NC													
Rated thermal current (Ith)	10A													
Rated operating voltage (Ue)	AC	380V												
	DC	220V												
Rated control capacity	AC-15	360VA												
	DC-13	33W												

Dimension(mm)

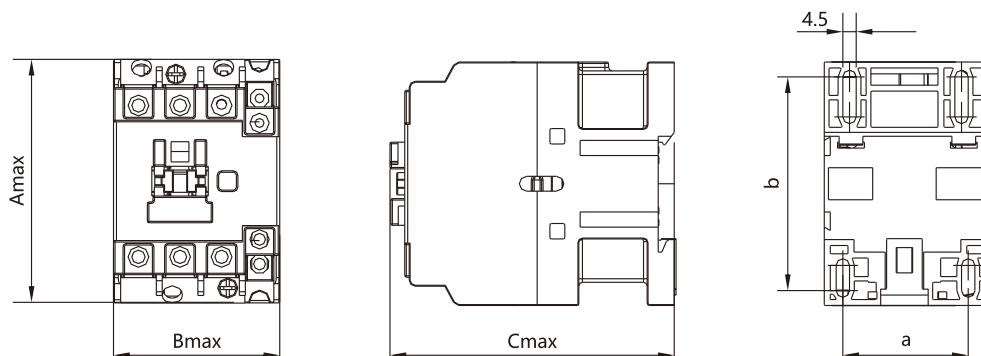

EKC2S-09~38

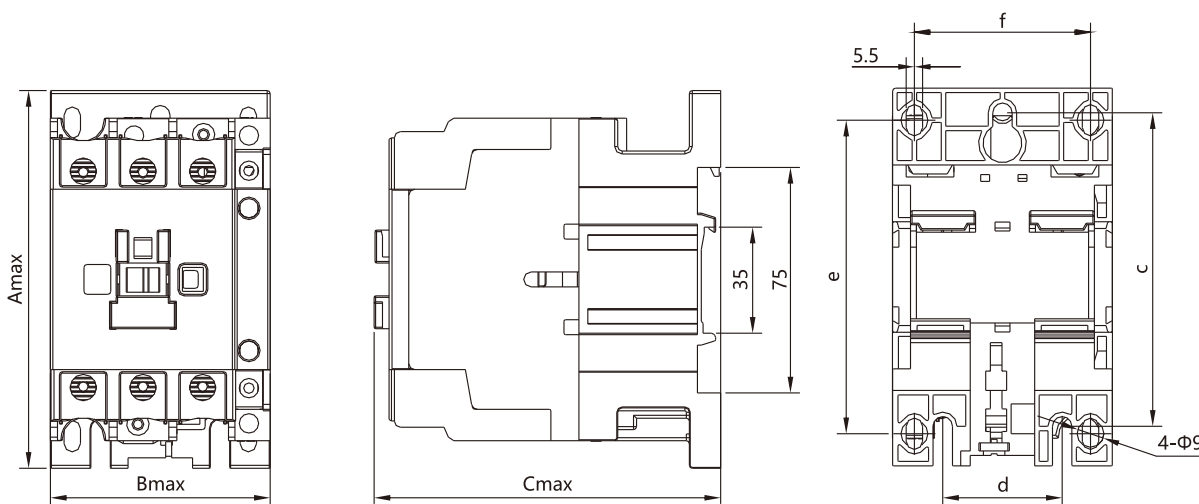

EKC2S-40~95

Type	Amax	Bmax	Cmax	a	b	c	d	e	f
EKC2S-09, 12, 18	74.5	45.5	85.5	35	50/60	-	-	-	-
EKC2S-25, 32	83	56.5	97	40	50/70	-	-	-	-
EKC2S-40, 50, 65	127.5	74.5	117	-	-	105	40	100/110	59
EKC2S-80, 95	127.5	85.5	125.5	-	-	105	40	100/110	67

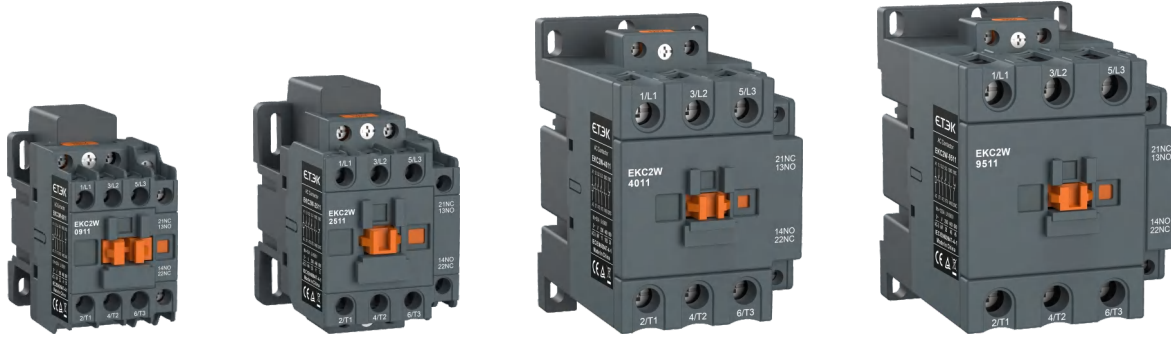

Product Overview

EKC2W Series wide voltage range contactors with AC/DC universal coil, are used for controlling 3-phase motors and power circuits up to 690 VAC and 250 VDC. These contactors are of the block type design with three main poles. Built-in 1NO+1NC auxiliary contact, resulting in installation time and cost savings.

- Wide control voltage range: AC/DC: 24~60V, 110~250V
- Can manage large control voltage variations: (85%~110%) Us
- Add-on auxiliary contact blocks for front or side mounting and a wide range of accessories.

Type Designation

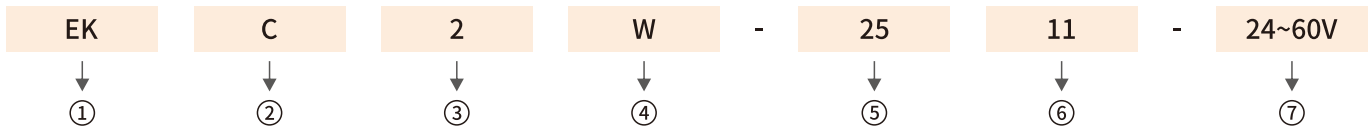

Code	Meaning
①	Company code
②	Contactors
③	Design sequence NO.
④	Wide control voltage range

Code	Meaning
⑤	Rated operational current (380V/400V, AC3): 9A,12A,18A,25A,32A,40A,50A,65A,80A,95A
⑥	Number of contacts 11: 3NO main contacts+1NO and 1NC auxiliary contact
⑦	Coil voltage: AC/DC 24~60V(9~95A); AC/DC 110~250V(9~95A)

Description

Application	Remote making & breaking circuits
	Protect circuit from over-load when assembling with thermal over-load relay
	Frequent start-up and control of AC contactor
Electric value	AC50/60Hz, 690V, up to 95A
Utilization category	AC-3, AC-4
Altitude	≤2000m
Ambient temperature	-5°C~+40°C
Mounting category	III
Mounting conditions	Inclination between the mounting plane and the vertical plane should not exceed ±5°
Standard	IEC/EN 60947-4-1, IEC/EN 60947-5-1

Technical Data

AC/DC control supply	Type	EKC2W-09	EKC2W-12	EKC2W-18	EKC2W-25	EKC2W-32	EKC2W-40	EKC2W-50	EKC2W-65	EKC2W-80	EKC2W-95
Main circuit characteristic											
Poles		3P									
Main contact		3NO									
Rated insulation voltage(Ui)(V)		690V									
Rated operating voltage(Ue)(V)		AC220/230V; 380/400V; 660/690V									
Rated thermal current(Ith), AC-1		20	20	32	40	50	60	80	80	100	125
Rated operation current(Ie)(A)	AC-3, 220/230V	9	12	18	25	32	40	50	65	80	95
	AC-4, 220/230V	3.5	5	7.7	8.5	12	18.5	24	28	37	44
	AC-3, 380/400V	9	12	18	25	32	40	50	65	80	95
	AC-4, 380/400V	3.5	5	7.7	8.5	12	18.5	24	28	37	44
	AC-3, 660/690V	6.6	8.9	12	18	22	34	39	42	49	49
	AC-4, 660/690V	1.5	2	3.8	4.4	7.5	9	12	14	17.3	21.3
Rated operational power(Pe)(A)	AC-3, 220/230V	2.2	3	4	5.5	7.5	11	15	18.5	22	25
	AC-4, 220/230V	0.6	1.1	1.5	2.2	3	5.5	6	7.5	11	14
	AC-3, 380/400V	4	5.5	7.5	11	15	18.5	22	30	37	45
	AC-4, 380/400V	1.5	2.2	3.3	4	5.4	7.5	11	15	18.5	22
	AC-3, 660/690V	5.5	7.5	10	15	18.5	30	33	37	45	45
	AC-4, 660/690V	1.1	1.5	3	3.7	5.5	7.5	10	11	15	18.5
Mechanical life($\times 10^6$ times)		10	10	10	10	8	8	8	8	6	6
Electrical life ($\times 10^3$ times)	AC-3	1000	1000	1000	1000	800	600	600	600	600	600
	AC-4	200	200	200	200	200	150	150	150	100	100
Frequency of operation (time/h)	AC-3	1200	1200	1200	1200	600	600	600	600	600	600
	AC-4	300	300	300	300	300	300	300	300	300	300
Control circuit characteristics											
Rated control voltage(Us)	50Hz	AC/DC: 24~60V, 110~250V									
	50/60Hz	AC/DC: 24~60V, 110~250V									
Allowed control circuit voltage	Operation	(85%~110%)Us									
	Release	(20%~75%)Us									
Power consumption of coil AC/DC	Actuation(VA)	≤ 130	≤ 130	≤ 130	≤ 130	≤ 130	≤ 300	≤ 300	≤ 300	≤ 300	≤ 300
	Keep(VA)	≤ 2	≤ 2	≤ 2	≤ 2	≤ 2	≤ 2	≤ 2	≤ 2	≤ 2	≤ 2
	Consumption(W)	≤ 2	≤ 2	≤ 2	≤ 2	≤ 2	≤ 3	≤ 3	≤ 3	≤ 3	≤ 3
AC/DC24-60V	Suction time(ms)	≤ 120									
AC/DC110-250V	Release time(ms)	≤ 90									
Energy efficiency rating AC/DC		Level 2									
Connecting capability of main circuit terminal											
Flexible wire No terminal	1 wire(mm ²)	1~4	1~4	1~4	1.5~10	1.5~10	4~25	4~25	4~25	6~50	6~50
	2 wire(mm ²)	1~4	1~4	1~4	1.5~6	1.5~6	4~16	4~16	4~16	6~25	6~25
Flexible wire With terminals	1 wire(mm ²)	1~4	1~4	1~4	1~6	1~6	4~25	4~25	4~25	6~50	6~50
	2 wire(mm ²)	1~2.5	1~2.5	1~2.5	1~4	1~4	4~10	4~10	4~10	6~16	6~16
Hard wire No terminal	1 wire(mm ²)	1~4	1~4	1~4	1.5~6	1.5~6	4~25	4~25	4~25	6~50	6~50
	2 wire(mm ²)	1~4	1~4	1~4	1.5~6	1.5~6	4~10	4~10	4~10	6~25	6~25
Fastening torque (N.m)		0.8	0.8	0.8	1.2	1.2	3.5	3.5	3.5	4	4
Auxiliary contacts											
Built-in auxiliary contact		1NO+1NC									
Rated thermal current (Ith)		10A									
Rated operating voltage (Ue)	AC	380V									
	DC	220V									
Rated control capacity	AC-15	360VA									
	DC-13	33W									

Electric Life Curves

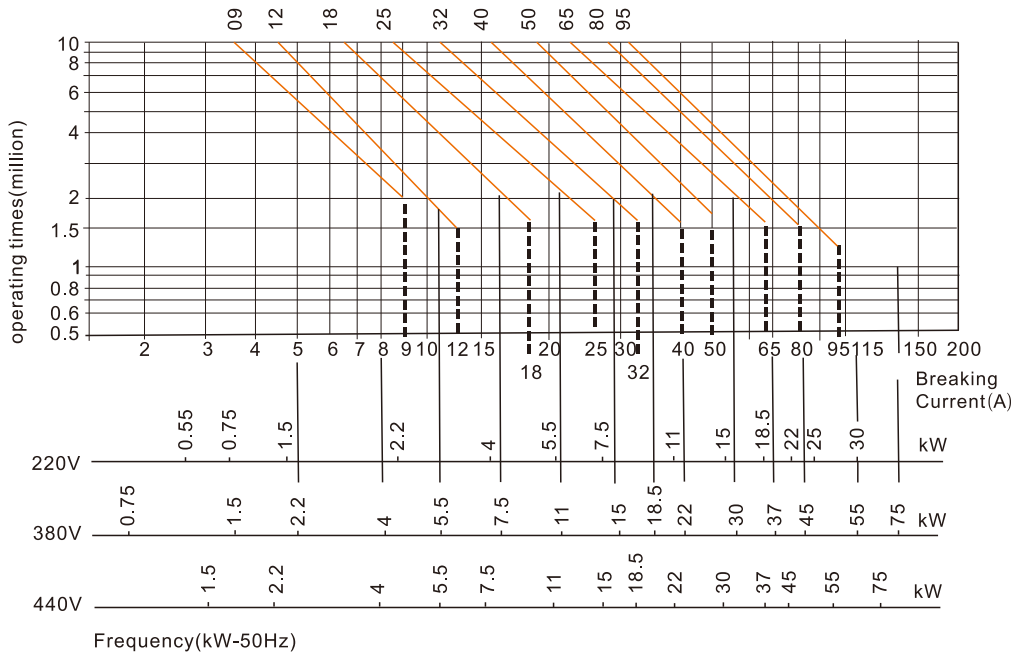

Dimension(mm)

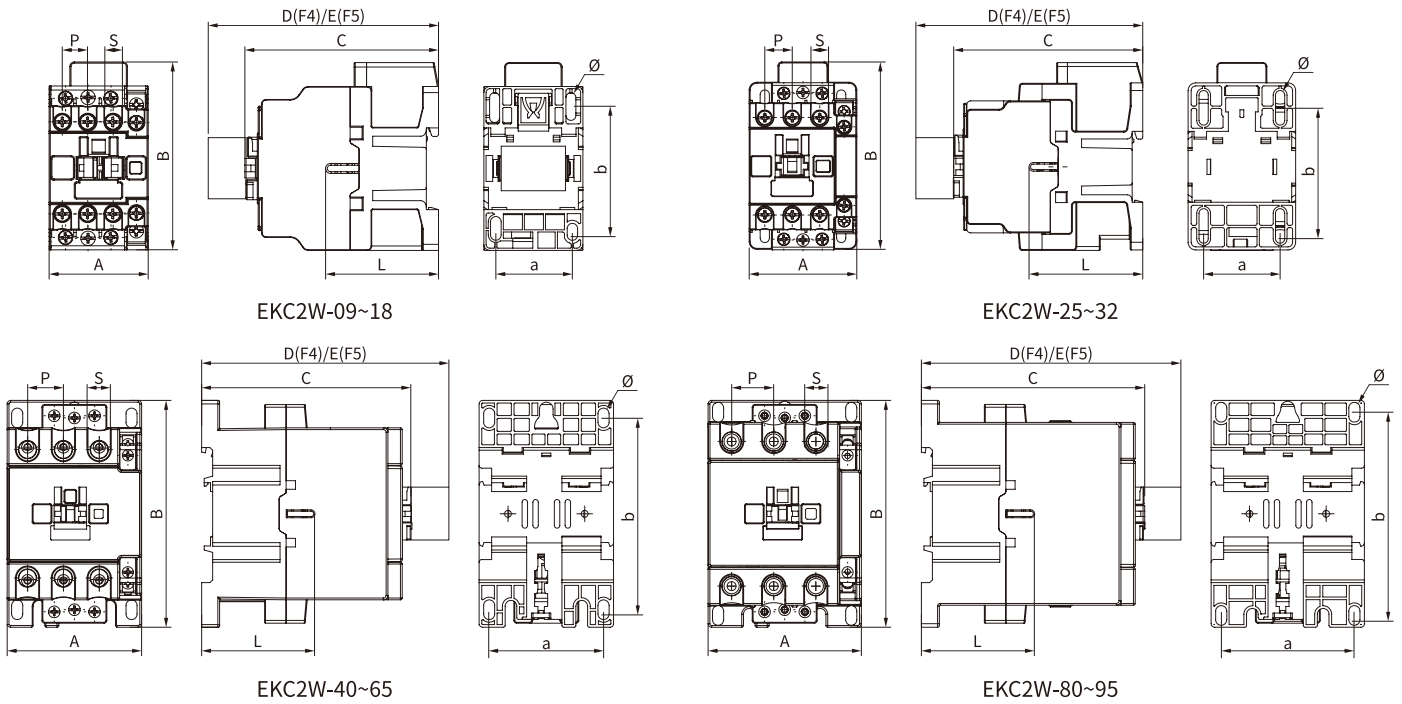

Model	A Max	B Max	C Max	D Max	E Max	a	b	Ø	L	P	S
EKC2W-09~18	45	85	87	120	124	34.5	50/60	4.5	51	11	10.5
EKC2W-25~32	56	98	98.6	132	136	40	61.5	4.5	59.3	14.2	13
EKC2W-40~65	75	127	118	151.1	155	63.5	105	6	63.2	20	14
EKC2W-80~95	86	126.5	126.5	158.5	162.5	74.5	105	6	63.2	23.5	17.5

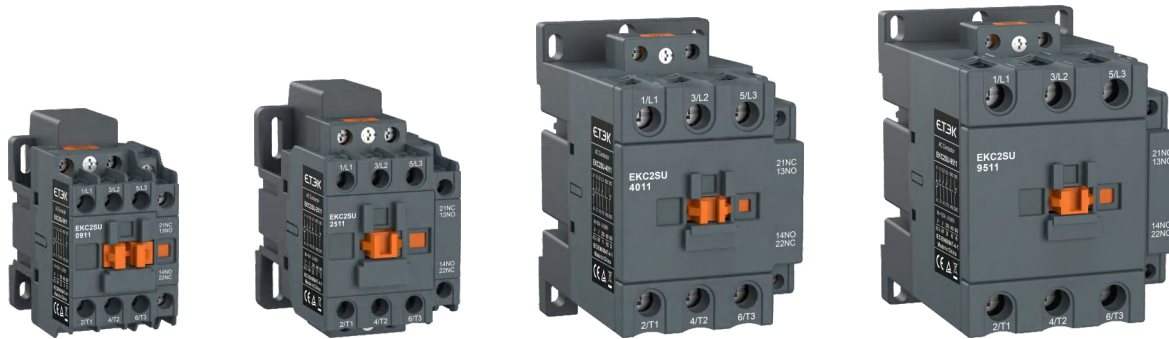

Product Overview

EKC2SU Series ac contactors are used for controlling 3-phase motor circuits up to 690V AC. These contactors are of the block type design with 3 main poles. Built-in 1NO+1NC auxiliary contact and surge suppression, resulting in installation time and cost savings.

Compared with contactors using external surge suppressors, contactor products using built-in surge suppressors will have more reliable performance and at the same time the surges are handled by the contactor itself and the surge never reaches the control circuit.

Type Designation

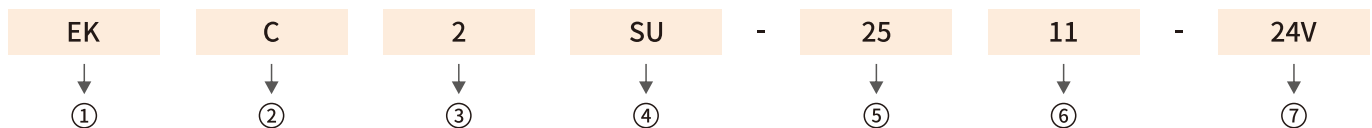

Code	Meaning
①	Company code
②	Contactors
③	Design sequence NO.
④	Built-in surge suppressors

Code	Meaning
⑤	Rated operational current (380V/400V, AC3): 9A,12A,18A,25A,32A,40A,50A,65A,80A,95A
⑥	Number of contacts 11: 3NO main contacts+1NO and 1NC auxiliary contact
⑦	Coil voltage: 24V,36V,48V,110V,230V,380V,415V,440V

Description

Application	Remote making & breaking circuits
	Protect circuit from over-load when assembling with thermal over-load relay
	Frequent start-up and control of AC contactor
Electric value	AC50/60Hz, 690V, up to 95A
Utilization category	AC-3, AC-4
Altitude	≤2000m
Ambient temperature	-5°C~+40°C
Mounting category	III
Mounting conditions	Inclination between the mounting plane and the vertical plane should not exceed ±5°
Standard	IEC/EN 60947-4-1, IEC/EN 60947-5-1

Technical Data

Type		EKC2SU-09	EKC2SU-12	EKC2SU-18	EKC2SU-25	EKC2SU-32	EKC2SU-40	EKC2SU-50	EKC2SU-65	EKC2SU-80	EKC2SU-95
Main circuit characteristic											
Poles		3P									
Main contact		3NO									
Rated insulation voltage(Ui)(V)		690V									
Rated operating voltage(Ue)(V)		AC220/230V; 380/400V; 660/690V									
Rated thermal current(Ith), AC-1		20	20	32	40	50	60	80	80	100	125
Rated operation current(Ie)(A)	AC-3, 220/230V	9	12	18	25	32	40	50	65	80	95
	AC-4, 220/230V	3.5	5	7.7	8.5	12	18.5	24	28	37	44
	AC-3, 380/400V	9	12	18	25	32	40	50	65	80	95
	AC-4, 380/400V	3.5	5	7.7	8.5	12	18.5	24	28	37	44
	AC-3, 660/690V	6.6	8.9	12	18	22	34	39	42	49	49
	AC-4, 660/690V	1.5	2	3.8	4.4	7.5	9	12	14	17.3	21.3
Rated operational power(Pe)(A)	AC-3, 220/230V	2.2	3	4	5.5	7.5	11	15	18.5	22	25
	AC-4, 220/230V	0.6	1.1	1.5	2.2	3	5.5	6	7.5	11	14
	AC-3, 380/400V	4	5.5	7.5	11	15	18.5	22	30	37	45
	AC-4, 380/400V	1.5	2.2	3.3	4	5.4	7.5	11	15	18.5	22
	AC-3, 660/690V	5.5	7.5	10	15	18.5	30	33	37	45	45
	AC-4, 660/690V	1.1	1.5	3	3.7	5.5	7.5	10	11	15	18.5
Mechanical life($\times 10^6$ times)		10	10	10	10	8	8	8	8	6	6
Electrical life($\times 10^5$ times)	AC-3	1000	1000	1000	1000	800	600	600	600	600	600
	AC-4	200	200	200	200	200	150	150	150	100	100
Frequency of operation (time/h)	AC-3	1200	1200	1200	1200	600	600	600	600	600	600
	AC-4	300	300	300	300	300	300	300	300	300	300
Control circuit characteristics											
Rated control voltage(Us)	50Hz	24V,36V,48V,110V,230V,380V,415V,440V									
	50/60Hz	24V,36V,48V,110V,230V,380V,415V,440V									
Allowed control circuit voltage	Operation	(85%~110%)Us									
	Release	(20%~75%)Us									
Power consumption of coil	Actuation(VA)	70	70	70	110	110	200	200	200	200	200
	Keep(VA)	9.5	9.5	9.5	11.4	11.4	38.8	38.8	38.8	38.8	38.8
	Consumption(W)	1-3	1-3	1-3	1-3	1-3	6-10	6-10	6-10	6-10	6-10
50/60Hz	Suction time(ms)	40	40	40	50	50	70	70	70	70	70
	Release time(ms)	130	130	130	150	150	170	170	170	170	170
Surge suppressors A1O-□-II-OA2	RC type	AC/DC 24V,36V,48V,110V,250V,380V,415V,440V									
Connecting capability of main circuit terminal											
Flexible wire No terminal	1 wire(mm ²)	1~4	1~4	1~4	1.5~10	1.5~10	4~25	4~25	4~25	6~50	6~50
	2 wire(mm ²)	1~4	1~4	1~4	1.5~6	1.5~6	4~16	4~16	4~16	6~25	6~25
Flexible wire With terminals	1 wire(mm ²)	1~4	1~4	1~4	1~6	1~6	4~25	4~25	4~25	6~50	6~50
	2 wire(mm ²)	1~2.5	1~2.5	1~2.5	1~4	1~4	4~10	4~10	4~10	6~16	6~16
Hard wire No terminal	1 wire(mm ²)	1~4	1~4	1~4	1.5~6	1.5~6	4~25	4~25	4~25	6~50	6~50
	2 wire(mm ²)	1~4	1~4	1~4	1.5~6	1.5~6	4~10	4~10	4~10	6~25	6~25
Fastening torque (N.m)		0.8	0.8	0.8	1.2	1.2	3.5	3.5	3.5	4	4
Auxiliary contacts											
Built-in auxiliary contact		1NO+1NC									
Rated thermal current (Ith)		10A									
Rated operating voltage (Ue)	AC	380V									
	DC	220V									
Rated control capacity	AC-15	360VA									
	DC-13	33W									

Electric Life Curves

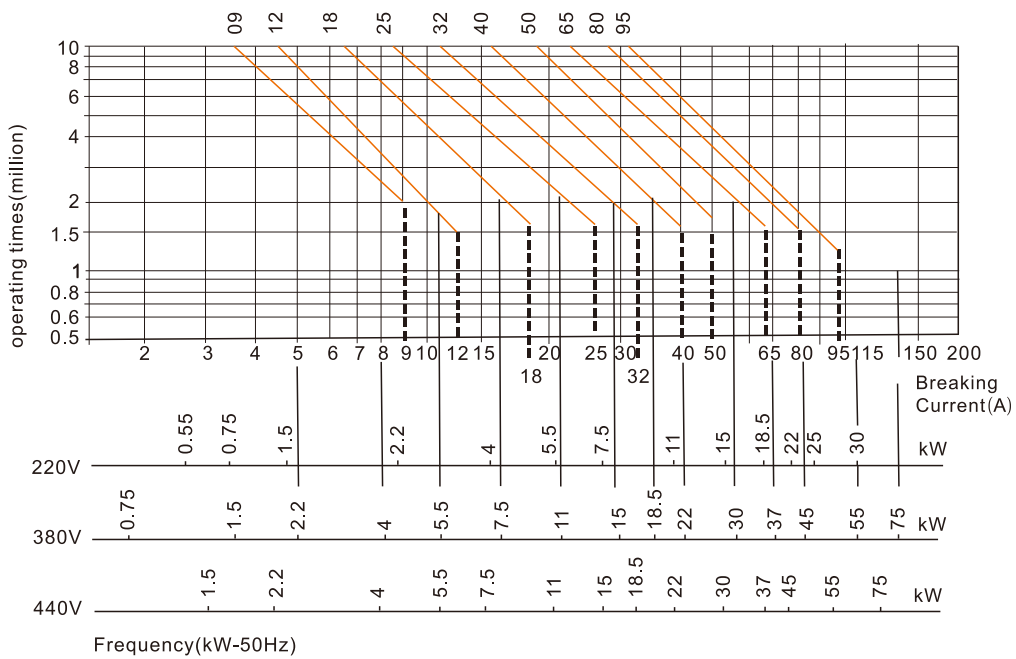

Dimension(mm)

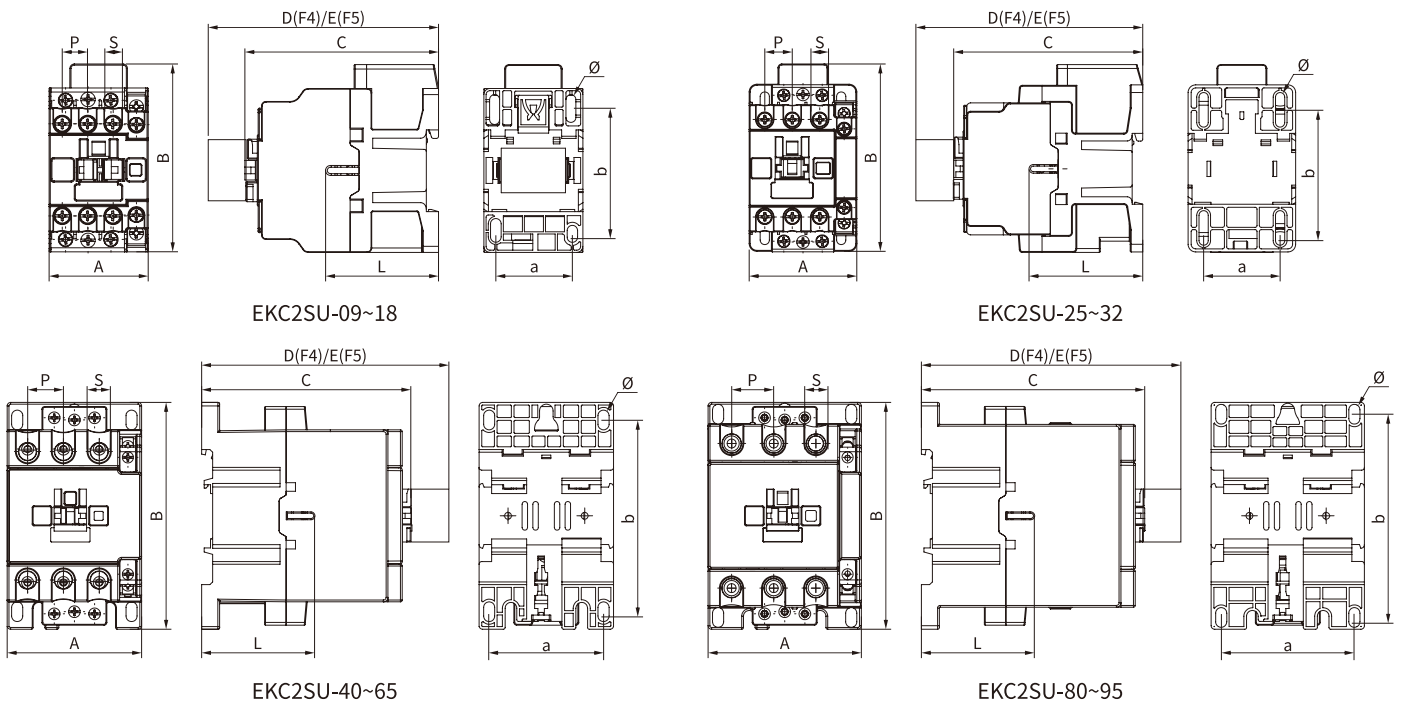

Model	A Max	B Max	C Max	D Max	E Max	a	b	Ø	L	P	S
EKC2SU-09~18	45	85	87	120	124	34.5	50/60	4.5	51	11	10.5
EKC2SU-25~32	56	98	98.6	132	136	40	61.5	4.5	59.3	14.2	13
EKC2SU-40~65	75	127	118	151.1	155	63.5	105	6	63.2	20	14
EKC2SU-80~95	86	126.5	126.5	158.5	162.5	74.5	105	6	63.2	23.5	17.5



Product Overview

EKC2F-115~800 series AC contactors (hereinafter referred to as contactors) are mainly used for AC 50HZ (or 60HZ), with a rated insulation voltage of 1000V, and a rated working current of 115 when the rated working voltage is 415V under the AC-3 use category. In circuits of ~800A, it is used for long-distance making and breaking of circuits, frequent starting and controlling AC motors; and it can be combined with a suitable thermal overload relay to form an electromagnetic starter to protect circuits that may be overloaded.

EKC2F-1000~2600 AC contactor (hereinafter referred to as contactor) is mainly used for remote power supply in AC circuits under AC-1 usage category, AC 50Hz (or 60Hz), rated working voltage to 690V, rated working current 1000~2600A Distance makes and breaks circuits.

Standard: IEC60947-4-1, IEC60947-5-1.

Type Designation

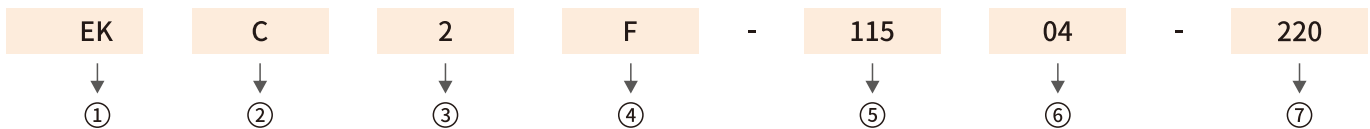

Code	Meaning
①	Company code
②	Contactor
③	Design sequence NO.
④	High current

Code	Meaning
⑤	Rated operational current: 115A,150A,185A,225A,265A,330A,400A,500A,630A, 800A,1000A,1250A,1400A,1700A,2100A,2600A
⑥	04: Main circuit 4P; Blank: Main circuit 3P
⑦	Coil voltage

Description

Ambient temperature	-25°C~+40°C
Altitude	≤3000m
Ambient humidity	The ultimate humidity does not exceed 95%, the duration does not exceed 24 hours, and measures are required to prevent condensation; When the ambient temperature is high, the humidity is required to be low. For example, when the temperature exceeds +40°C, the humidity is required to not exceed 50%.
Pollution level	3 level
Protection level	IP20
Installation category	III
Installation direction	Installed vertically, and the inclination between the installation surface and the vertical surface is ≤30°
Installation method	Screw installation

Technical Data

Type		EKC2F-115	EKC2F-150	EKC2F-185	EKC2F-225	EKC2F-265	EKC2F-330	EKC2F-400	EKC2F-500	EKC2F-630	EKC2F-800
Main circuit characteristic											
Poles		3P, 4P									
Rated impulse withstand voltage (U _{imp})(kV)		8									
Rated insulation voltage (U _i)(V)		1000									
Rated operating voltage (U _e)(V)		380/415; 660/690									
Rated thermal current (I _{th})(A)		200	200	275	280	350	360	500	580	850	850
Rated operation current (I _e)(A)	AC-3, 415V	115	150	185	225	265	330	400	500	630	800
	AC-3, 690V	86	107	118	135	170	225	305	335	460	470
	AC-4, 415V	52	60	79	85	105	117	138	147	188	195
	AC-4, 690V	49	57	69	82	98	107	135	145	170	175
Rated turn-on capacity		10×I _e (AC-3), 12×I _e (AC-4), 1.5×I _e (AC-1)									
Rated breaking capacity		8×I _e (AC-3), 10×I _e (AC-4), 1.5×I _e (AC-1)									
Mechanical life(×10 ⁴ times)		300									
Electrical life (×10 ⁴ times)	AC-3	80	80	50	50	50	50	30	20	20	20
	AC-4	15	15	15	15	15	15	8	8	5	3
Frequency of operation (h ⁻¹)	AC-3	600	600	600	600	300	300	300	300	300	300
	AC-4	150	150	150	150	150	150	150	150	150	150
Average impedance per pole at I _{th} and 50Hz(mΩ)		0.37	0.35	0.33	0.32	0.3	0.28	0.26	0.18	0.12	0.12
Shock resistance 1/2 sine wave= 11ms (gn)	Contact open	9	9	7	7	6	6	6	9	9	6
	Contact close	15	15	15	15	15	15	15	15	15	15
Vibration resistance 5...300 Hz (gn)	Contact open	2	2	2	2	2	2	1.5	2	2	2
	Contact close	6	6	6	6	5	5	5	4	4	4
Control circuit characteristics											
Rated control voltage (U _c)		24,36,48,110,220, 240,380,415,480 (50Hz,50/60Hz)		110,200,220,230, 240,380,400,415 (50Hz,50/60Hz)		110,220,230, 380,400 (50/60Hz)		110,220,230,380 (50/60Hz)			
Operation voltage range		(85%~110%)U _c									
Release voltage range		(20%~75%)U _c									
Power consumption of coil	Operation(VA)	≤550(50Hz) ≤855(50/60Hz)		≤805(50Hz) ≤1180(50/60Hz)		≤650	≤650	≤1075	≤1100	≤1650	≤1700
	Keep(VA)	≤55(50Hz) ≤9(50/60Hz)		≤64(50Hz) ≤14(50/60Hz)		≤15	≤15	≤22	≤24	≤27	≤27
Coil operation time(ms)		23~35		20~35		40~65	40~65	40~75	40~75	40~80	60~80
Coil release time(ms)		5~15(50Hz) 130(50/60Hz)		7~15(50Hz) 130(50/60Hz)		100~170	100~170	100~170	100~170	100~200	150~180
Connecting capability of main circuit											
Cable	Quantity	1	1	1	1	1	1	2	2	/	/
	Size (mm ²)	95	120	150	185	240	250	150	240	/	/
Copper row	Quantity	2	2	2	2	2	2	2	2	2	2
	Size (mm)	20×3	25×3	25×3	32×4	32×4	30×5	30×5	40×5	60×5	60×5
Connecting capability of control circuit											
Number of flexible wire 1 or 2 (mm ²)		2.5									
Number of hard wire 1 (mm ²)		4									
Tightening torque (N.m)		1.2									

Type	EKC2F-1250	EKC2F-1000	EKC2F-1400	EKC2F-1700	EKC2F-2100	EKC2F-2600
Main circuit characteristic						
Poles	3P, 4P					
Rated impulse withstand voltage (Uimp)(kV)	12					
Rated insulation voltage (Ui)(V)	1000					
Rated operating voltage (Ue)(V)	660/690					
Rated thermal current (Ith)(A)	1250	1000	1400	1700	2100	2600
Rated operating current (Ie)(A) (open installation) AC-1, Ue≤690V, θ≤40°C	1250	1000	1400	1700	2100	2600
Rated turn-on capacity	1.5×Ie (AC-1)					
Rated breaking capacity	1.5×Ie (AC-1)					
Mechanical life(×10 ⁴ times)	100	100	60	60	60	60
Maximum mechanical operating frequency	600 times/h					
Electrical life AC-1 (×10 ⁴ times)	8	8	7	7	4	3
Frequency of operation AC-1 (h ⁻¹)	200 times/h					
Average impedance per pole At Ith and 50Hz(mΩ)	0.12	0.12	0.1	0.1	0.1	0.1
Shock resistance 1/2 sine wave=11ms (gn)	Contactor open	6				
	Contactor close	15				
Vibration resistance 5...300 Hz (gn)	Contactor open	2				
	Contactor close	4				
Control circuit characteristics						
Rated control voltage (Uc)	110,220,230,380 (50/60Hz)	110, 110~120, 220, 220~230, 240, 277, 380, 380~400, 415~400 (50/60Hz)				
Operation voltage range	(85%~110%)Uc					
Release voltage range	(20%~75%)Uc					
Power consumption of coil	Operation(VA)	≤1700	≤2200	≤2200	≤2200	≤2200
	Keep(VA)	≤27	≤44	≤44	≤44	≤44
Coil operation time(ms)	60~80	40~75	40~75	40~75	40~75	40~75
Coil release time(ms)	150~180	100~170	100~170	100~170	100~170	100~170
Connecting capability of main circuit						
Copper row	Quantity	2	2	3	3	4
	Size (mm)	100×5	100×5	100×5	100×5	100×5
Connecting capability of control circuit						
Number of flexible wire 1 or 2 (mm ²)	2.5					
Number of hard wire 1 (mm ²)	4					
Tightening torque (N.m)	1.2					

Dimension(mm)

EKC2F-115~330

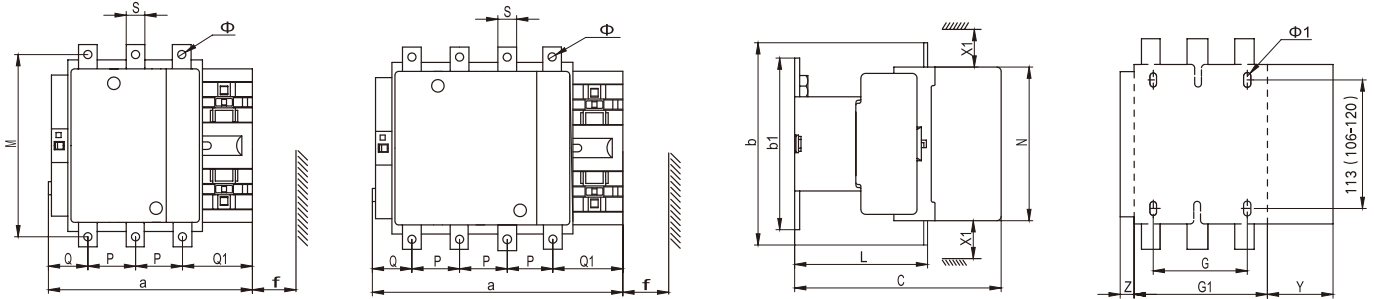

Model	a	p	Q	Q1	S	Φ	f	b	b1	M	N	c	L	G	Φ1	G1	Z	Y	X1	
																			≤500V	>500V
EKC2F-115	163.5	37	29.5	60	15	6.5	131	162	137	147	124	171	107	80	6.5	106	13.5	44	10	15
EKC2F-11504	200.5	37	29.5	60	15	6.5	131	162	137	147	124	171	107	80	6.5	143	13.5	44	10	15
EKC2F-150	163.5	40	26	57.5	20	9	131	170	137	150	124	171	107	80	6.5	106	13.5	44	10	15
EKC2F-15004	200.5	40	26	55.5	20	9	131	170	137	150	124	171	107	80	6.5	143	13.5	44	10	15
EKC2F-185	168.5	40	29	59.5	20	9	130	174	137	154	127	181	113.5	80	6.5	111	13.5	44	10	15
EKC2F-18504	208.5	40	29	59.5	20	9	130	174	137	154	127	181	113.5	80	6.5	151	13.5	44	10	15
EKC2F-225	168.5	48	21	51.5	25	11	130	197	137	172	127	181	113.5	80	6.5	111	13.5	44	10	15
EKC2F-22504	208.5	48	17	47.5	25	11	130	197	137	172	127	181	113.5	80	6.5	151	13.5	44	10	15
EKC2F-265	201.5	48	39	66.5	25	11	147	203	145	178	147	213	141	96	6.5	140	20.5	38	10	15
EKC2F-26504	224.5	48	34	66.5	25	11	147	203	145	178	147	213	141	96	6.5	186	20.5	38	10	15
EKC2F-330	213	48	43	74	25	11	147	206	145	181	158	219	145	96	6.5	154.5	20.5	38	10	15
EKC2F-330	261	48	43	74	25	11	147	206	145	181	158	219	145	96	6.5	202.5	20.5	38	10	15

Note: For the space required to replace the coil, X1 is the minimum electrical gap (flashover distance), which is the same as below.

EKC2F-400~500

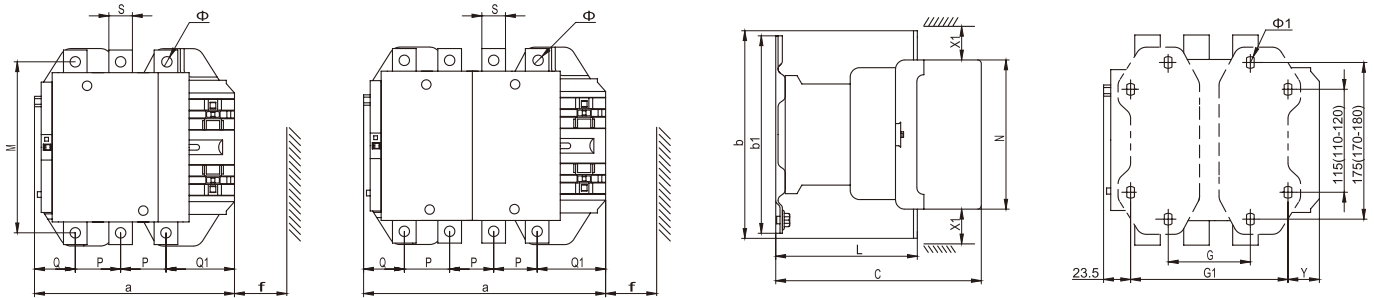

Model	a	p	Q	Q1	S	Φ	f	b	b1	M	N	c	L	G	G1	Φ1	Y	X1	
																		≤500V	>500V
EKC2F-400	213	48	43	74	25	11	151	206	209	181	158	219	145	80 (66-102)	170 (156-192)	8.5	19.5	15	20
EKC2F-40004	261	48	43	74	25	11	151	206	209	181	158	219	145	80 (66-150)	170 (156-240)	8.5	67.5	15	20
EKC2F-500	233	55	46	77	30	11	169	238	209	208	172	232	146	80 (66-120)	170 (156-210)	8.5	39.5	15	20
EKC2F-50004	288	55	46	77	30	11	169	238	209	208	172	232	146	140 (66-175)	230 (156-265)	8.5	34.5	15	20

EKC2F-630~800

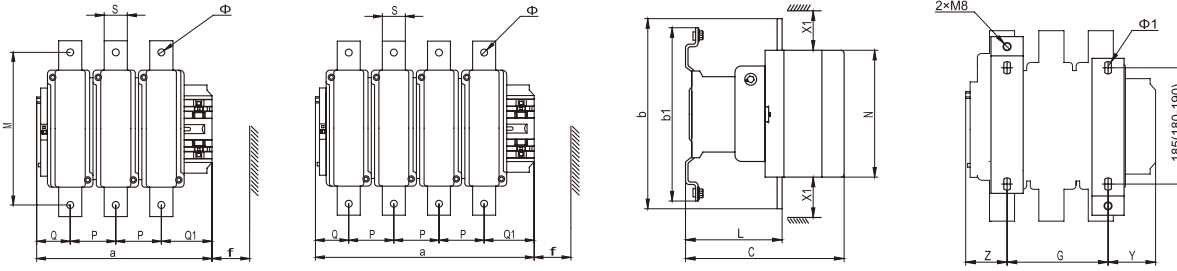

Model	a	p	Q	Q1	S	Φ	f	b	b1	M	N	c	L	G	Φ1	Z	Y	X1	
																		≤500V	>500V
EKC2F-630 EKC2F-800	309	80	60	89	40	13	201	304	280	264	202	255	155	180 (100-195)	10.5	60.5	68.5	20	30
EKC2F-63004 EKC2F-80004	389	80	60	89	40	13	201	304	280	264	202	255	155	240 (150-275)	10.5	60.5	88.5	20	30

EKC2F-1250

I type overall dimension

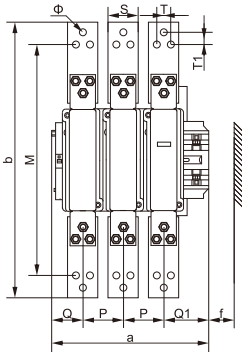

C type overall dimension

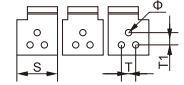
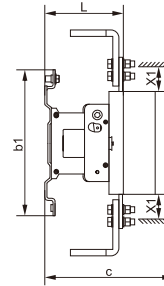
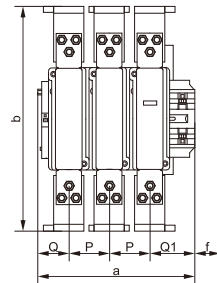
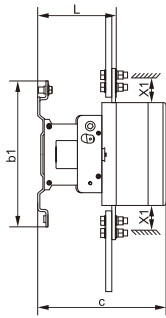

T type overall dimension

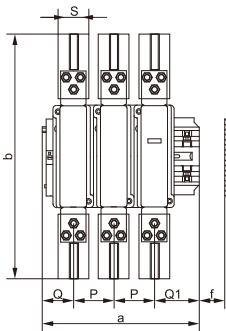

Installation Dimension

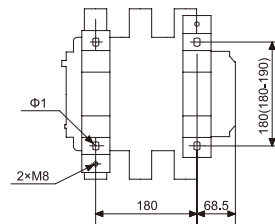
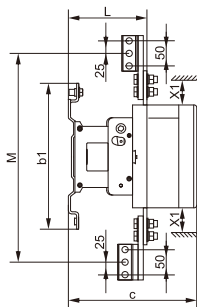

EKC2F-1250	a	p	Q	Q1	S	g	T	T1	Φ	f	b	b1	M	c	L	Φ1	X1	
																	≤500V	>500V
I type row connection	309	80	60	89	60	/	28	24	13	151	512	280	424	251	155	10.5	20	30
C type row connection	309	80	60	89	80	20	28	24	13	151	462	280	/	251	155	10.5	20	30
T type row connection	309	80	60	89	50	/	/	/	13	151	442	280	370.5	251	155	10.5	20	30

Note: Choose any one of the above three connection rows.

EKC2F-1000~2100

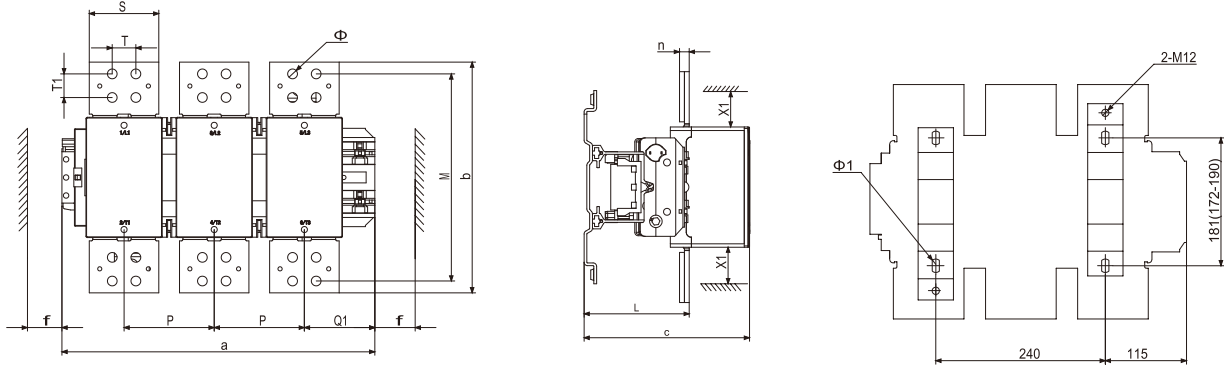

EKC2F-2600

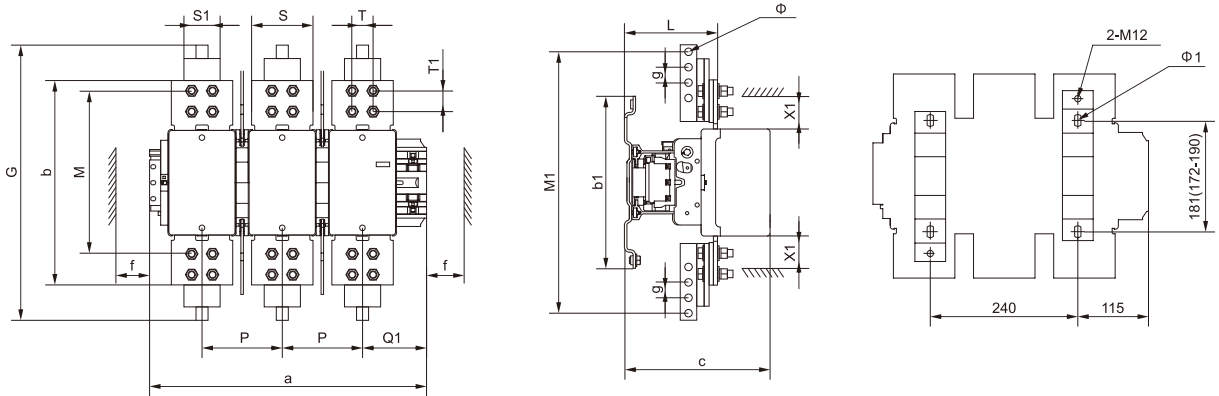

Model	a	b	c	L	n	p	Q1	M	Φ	Φ1	S	S1	T	T1	f	G	g	M1	X1 (Ue≤690V)
EKC2F-1000	448	332	238	151	12	130.5	104	298	13	10.5	100	/	34	34	170	/	/	/	100
EKC2F-1400	448	332	238	151	12	130.5	104	298	13	10.5	100	/	34	34	170	/	/	/	100
EKC2F-1700	448	332	238	151	12	130.5	104	298	13	10.5	100	/	34	34	170	/	/	/	100
EKC2F-2100	448	332	238	151	12	130.5	104	298	13	10.5	100	/	34	34	170	/	/	/	100
EKC2F-2600	448	332	238	148	20	130	104	298	13	10.5	100	60	34	34	170	480	25	458	100



Product Overview

EKC2-M series AC contactor with novel appearance and compact structure is suitable for using starting & controlling the AC motor frequently, switching on and off the circuit at a long distance. It is used in combination with thermal relay to compose a magnetic motor starter.

Standard: IEC 60947-1, IEC 60947-4-1.

Type Designation

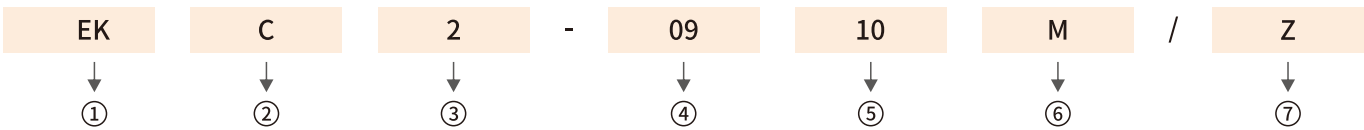

Code	Meaning
①	Company code
②	Contactor
③	Design sequence NO.
④	Rated current (380V/400V, AC3): 6A, 9A, 12A

Code	Meaning
⑤	Number of contacts (reversible contactors represent the types and quantities of contacts for a single product) 10: 3NO main contacts+1NO auxiliary contact 01: 3NO main contacts+1NC auxiliary contact 04: 4NO main contacts 08: 2NO and 2NC main contacts
⑥	M represents mini contactor
⑦	Z represents DC operation, N represents reversible AC contactor

Operating and Installation Conditions

Type	Operating and Installation Conditions
Installation category	III
Pollution level	3
Certification	CE, CB, TUV
Protection degree	IP20
Ambient temperature	limit of temperature: -35°C~+70°C, normal temperature: -5°C~+40°C, The average no more than +35°C within 24 hours. If not in normal operating temperature range, please refer to "Instructions for abnormal environment"
Altitude	≤2000m
Ambient temperature	The maximum temperature of 70 degrees, the air relative humidity not exceed 50%, under lower temperature can allow for higher relative humidity. If the temperature is 20°C, the air relative humidity could up to 90%, Special measures should be taken for occasional condensation due to humidity changes.
Installation position	Inclination between installation surface and vertical surface should not exceed ±5°
Shock vibration	Products should be installed and used without significant shake, shock and vibration place.

Technical Data

Type		EKC2-06M	EKC2-09M	EKC2-12M
Main circuit characteristic				
Poles			3P/4P	
Main contact			3NO	
Rated insulation voltage(Ui)(V)			690V	
Rated operating voltage(Ue)(V)			380/400V; 660/690V	
Rated thermal current(Ith), AC-1			20	
Rated operation current(Ie)(A)	AC-3, 380/400V	6	9	12
	AC-3, 660/690V	3.8	4.9	4.9
	AC-4, 380/400V	6	9	9
	AC-4, 660/690V	3.8	4.9	4.9
Rated operational power(Pe)(A)	AC-3, 380/400V	2.2	4	5.5
	AC-3, 660/690V	3	4	4
Mechanical life($\times 10^3$ times)			1200	
Electrical life ($\times 10^3$ times)	AC-3		120	
	AC-4		See electrical life curve	
Frequency of operation (time/h)	AC-3		1200	
	AC-4		300	
Control circuit characteristics				
Rated control voltage (Us)	50Hz		24V,36V,48V,110V,127V,220V,380V,415V	
	50/60Hz		24V,36V,48V,110V,127V,220V,380V,415V	
	DC		12V,24V,36V,48V,110V,127V,220V	
Allowed control circuit voltage	Operation	Installation inclination angle $\pm 22.5^\circ$: (85%~110%)Us; Installation inclination angle $\pm 5^\circ$: 70%~120%		
	Release(AC)	Installation inclination angle $\pm 22.5^\circ$: (20%~75%)Us; Installation inclination angle $\pm 5^\circ$: 20%~60%		
	Release(DC)	Installation inclination angle $\pm 22.5^\circ$: (10%~75%)Us; Installation inclination angle $\pm 5^\circ$: 10%~60%		
Power consumption of coil	Actuation(VA)		20~40	
	Keep(VA)		9.5	
	Consumption(W)		1~3	
Connecting capability of main circuit terminal				
Flexible wire No terminal	1 wire(mm ²)		1~4	
	2 wire(mm ²)		1~4	
Flexible wire With terminals	1 wire(mm ²)		1~4	
	2 wire(mm ²)		1~2.5	
Hard wire No terminal	1 wire(mm ²)		1~4	
	2 wire(mm ²)		1~4	
Fastening torque (N.m)			1.2	
Auxiliary contacts				
Built-in auxiliary contact			1NO/1NC	
Rated thermal current (Ith)			10A	
Rated operating voltage (Ue)	AC		380/400V	
	DC		220V	
Rated control capacity	AC-15		Ue/Ie: AC380V/400V/1.5A; Ith: 10A	
	DC-13		Ue/Ie: DC220V/0.3A	

Selection Table

Motor power kW		Maximum operation current A	Number of contacts contained in the contactor body		Contactor model
380/400V	660/690V		AC-3 380/400V	NO	
2.2	3	6	1	0	EKC2-0610M
2.2	3	6	0	1	EKC2-0601M
2.2	3	6	0	0	EKC2-0604M
2.2	3	6	0	0	EKC2-0608M
4	4	9	1	0	EKC2-0910M
4	4	9	0	1	EKC2-0901M
4	4	9	0	0	EKC2-0904M
4	4	9	0	0	EKC2-0908M
5.5	4	12	1	0	EKC2-1210M
5.5	4	12	0	1	EKC2-1201M
5.5	4	12	0	0	EKC2-1204M
5.5	4	12	0	0	EKC2-1208M

Coil Voltage Specification Table

AC(V) 50Hz	24	36	48	110	127	220	380	415
AC(V) 60Hz	24	36	48	110	127	220	380	415
AC(V) 50/60Hz	24	36	48	110	127	220	380	415
DC(V)	12	24	36	48	110	127	220	-

Instructions For Use of Correction Factors In High Altitude Areas

Altitude (m)	2000	3000	4000
Rated impulse withstand voltage correction factor	1	0.88	0.78
Rated operation current correction factor	1	0.92	0.90

Instructions For Use Under Abnormal Ambient Temperature

Ambient temperature (°C)	55	60	65	70
Correction factor	1	0.93	0.875	0.75

EKC2-M



Mini Contactor 6~12A

Standard_ IEC60947-1
IEC60947-4-1

Dimension(mm)

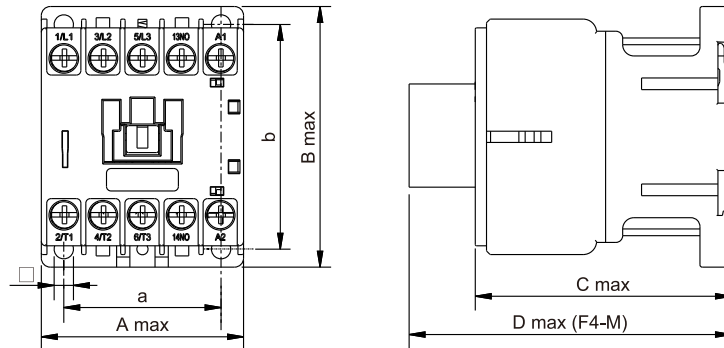

Model	A Max	B Max	C Max	D Max	a	b	Ø
EKC2-06M~12M	45.5	59	58	94	35±0.35	50±0.48	4.2
EKC2-06M/Z~12M/Z	45.5	59	70	106	35±0.35	50±0.48	4.2

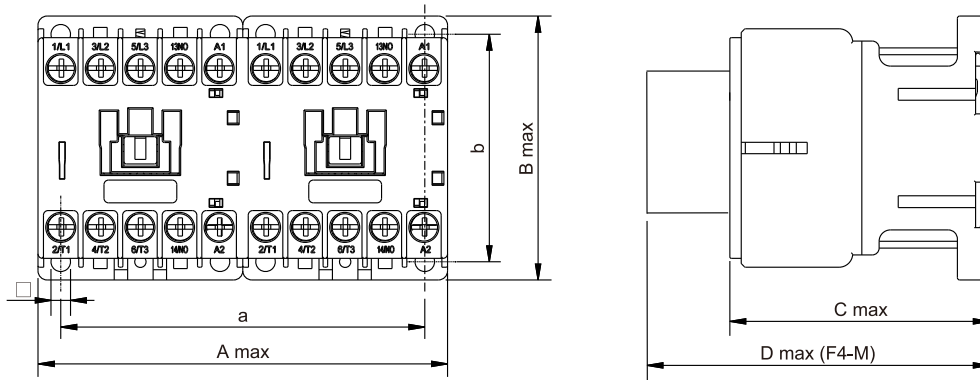

Model	A Max	B Max	C Max	D Max	a	b	Ø
EKC2-06M/N~12M/N	91	59	58	94	80±0.35	50±0.48	4.2
EKC2-06M/Z/N~12M/Z/N	91	59	70	106	80±0.35	50±0.48	4.2



Feature

- 3-phase bimetal
- Continuously readjustable current settings
- Temperature compensation
- Tripping indicator
- Test button
- Stop button
- Manual and automatic reset button
- Electrically separated 1NO plus 1NC contact

Type Designation

EK	R	2	-	25	11
↓	↓	↓		↓	↓
①	②	③		④	⑤

Code	Meaning	Code	Meaning
①	Company code	④	Frame Size
②	Thermal overload relay	⑤	Code of current rating Basic specification, expressed with the rated operational current (380V/400V, AC3)
③	Design sequence Number		

Description

Electric value	AC50/60Hz, 690V, 0.1~93A
Tripping class	10A
Mounting version	Plug-in: Available for EKR2-13, 23, 33

Protection property

Item	Series No.	I/In		Operating time Tp	Test condition
Overload protection	1	1.05		>2 h	Start from cold status
	2	1.2		≤2h	Start from heat status, right after item No.1
	3	1.5		≤2min	Start from heat status, right after item No.1
	4	7.2		2s<Tp≤10s	Start from cold status
Phase failure protection	5	Any two phases	Another phases	>2 h	Start from cold status
		1.0	0.9		
	6	1.15	0	≤2 h	Start from heat status, right after item No.5

Curves

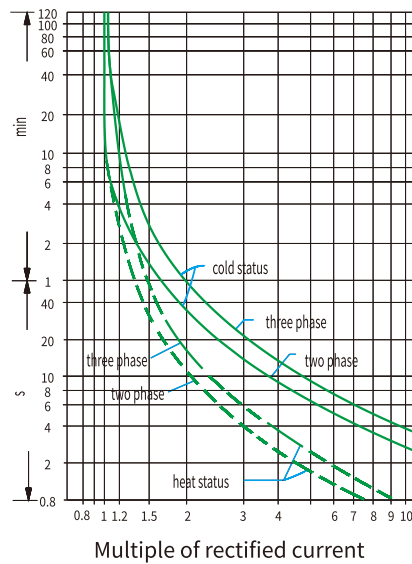

Technical Data

Phase failure protection function		Yes
Automatic & manual reset		Yes
Temperature compensation		Yes
Tripping indicator		Yes
Test & stop pushbutton		Yes
Mounting mode	Plug-in	Yes
	Independent	Yes
	No. of contacts	1NO+1NC
Auxiliary contacts	Rated current (A) (AC-15 220V)	2.73
	Rated current (A) (AC-15 380V)	1.58
	Rated current (A) (DC-13 220V)	0.2

Assembly with contactor

Model of overload relay	Code	Rated current (A)	Recommended fuse type(Recommended RT16)		Contactor Matched
			aM	gG	
EKR2-13	1301	0.1~0.16	0.25	2	EKC1/EKC2(S)-09 EKC1/EKC2(S)-12 EKC1/EKC2(S)-18 EKC1/EKC2(S)-25 EKC1/EKC2(S)-32
	1302	0.16~0.25	0.5	2	
	1303	0.25~0.4	1	2	
	1304	0.4~0.63	1	2	
	1305	0.63~1	2	4	
	1306	1~1.6	2	4	
	1307	1.6~2.5	4	6	
	1308	2.5~4	6	10	
	1310	4~6	8	16	
	1312	5.5~8	12	20	
	1314	7~10	12	20	
	1316	9~13	16	25	
	1321	12~18	20	35	
	1322	17~25	25	50	
EKR2-23	2353	23~32	40	63	EKC1/EKC2(S)-32
	2355	30~40	40	80	
EKR2-33	3353	23~32	40	63	EKC1/EKC2(S)-40 EKC1/EKC2(S)-50 EKC1/EKC2(S)-65 EKC1/EKC2(S)-80 EKC1/EKC2(S)-95
	3355	30~40	40	100	
	3357	37~50	63	100	
	3359	48~65	63	100	
	3361	55~70	80	125	
	3363	63~80	80	125	
	3365	80~93	100	160	

Dimension(mm)

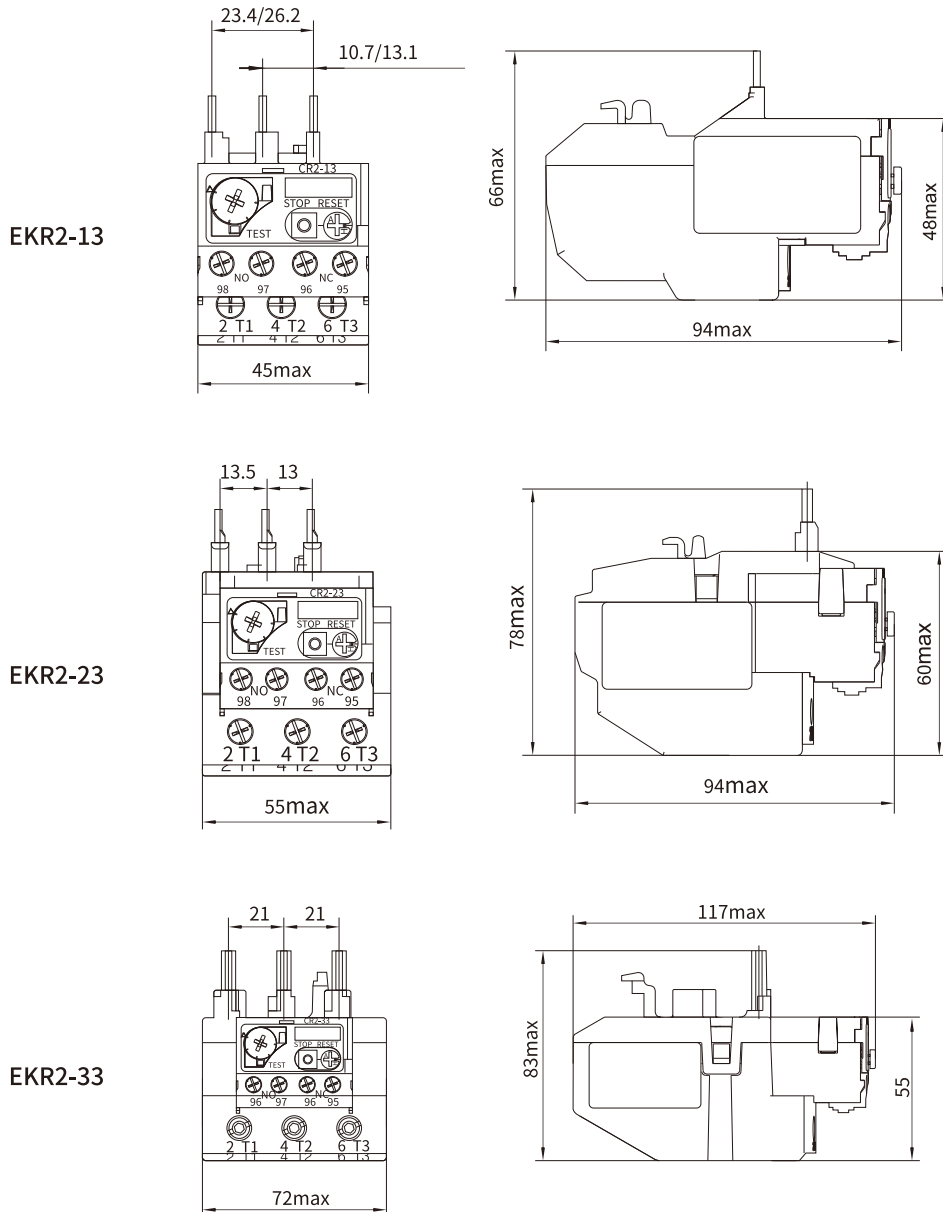

Items			EKR2-13	EKR2-23	EKR2-33
Cross section area of conductor mm ²	Main circuit	Single core or stranded wire	1~4	4~10	4~35
		Wiring screw	M4	M4	M10
	Auxiliary circuit	Single core or stranded wire	0.5~2.5	0.5~2.5	0.5~2.5
		Wiring screw	M3.5	M3.5	M3.5

	Sepecification	Model	Contact Number	Contact Number	Contactor Matched
	Auxiliary Contact 4-pole Front mount	EKF4-40G	4NO	EKC1/EKC2(S)-09~95 EKC2F-115~800	
		EKF4-31G	3NO+1NC		
		EKF4-22G	2NO+2NC		
		EKF4-13G	1NO+1NC		
		EKF4-04G	4NC		
	Auxiliary Contact 2-pole Front mount	EKF4-20G	2NO		
		EKF4-11G	1NO+1NC		
		EKF4-02G	2NC		
	Auxiliary Contact 4-pole Front mount	EKF4-40M	4NO	EKC2-06M~12M	
		EKF4-31M	3NO+1NC		
		EKF4-22M	2NO+2NC		
		EKF4-13M	1NO+3NC		
	Auxiliary Contact 2-pole Front mount	EKF4-20M	2NO		
		EKF4-11M	1NO+1NC		
		EKF4-02M	2NC		
	Auxiliary Contact 2-pole Side mount	EKF8-20	2NO	EKC1/EKC2(S)-09~95	
		EKF8-11	1NO+1NC		
		EKF8-02	2NC		
	1NO+1NC Pneumatic timer ON-delay	EKF5-T0	0.1~3s	EKC1/EKC2(S)-09~95 EKC2F-115~800	
		EKF5-T2	0.1~30s		
	1NO+1NC Pneumatic timer OFF-delay	EKF5-T4	10~180s		
		EKF5-D0	0.1~3s		
		EKF5-D2	0.1~30s		
		EKF5-D4	10~180s		
	Contactor Coil	EKX1-2	AC Volts	EKC1/EKC2(S)-09~18	
		EKX1-4	AC Volts	EKC1/EKC2(S)-25~32	
		EKX1-6	AC Volts	EKC1/EKC2(S)-40~95	
	Contactor Coil Water Proof	EKX1-6N	AC Volts	EKC1/EKC2(S)-40~95	
		EKX1-FF	AC Volts	EKC2F-115~150	
		EKX1-FG	AC Volts	EKC2F-185~225	
		EKX1-FH	AC Volts	EKC2F-265	
		EKX1-FJ	AC Volts	EKC2F-400	
		EKX1-FK	AC Volts	EKC2F-500	
		EKX1-FL	AC Volts	EKC2F-630	

	Sepecification	Model	Matched
	Accessories for Reversing/ change-over type contactor	EKA9-0932	EKC1/EKC2(S)-09~32
		EKA9-4095	EKC1/EKC2(S)-40~95
		EKA9-FF970	EKC2F-115~150
		EKA9-FB970	EKC2F-185~225
		EKA9-FH970	EKC2F-265~330
		EKA9-FJ970	EKC2F-400~500
		EKA9-FL970	EKC2F-630~800
	Mounting Block for Thermal Overload Relay	EKA9-1064	EKR2-13
		EKA9-2064	EKR2-23
		EKA9-3064	EKR2-33
	Sepecification	Model	Matched
	Surge Suppression Module	EKFS-M	AC/DC: 24-48V AC/DC: 110-240V AC/DC: 380-440V

Mounting Sketch Map

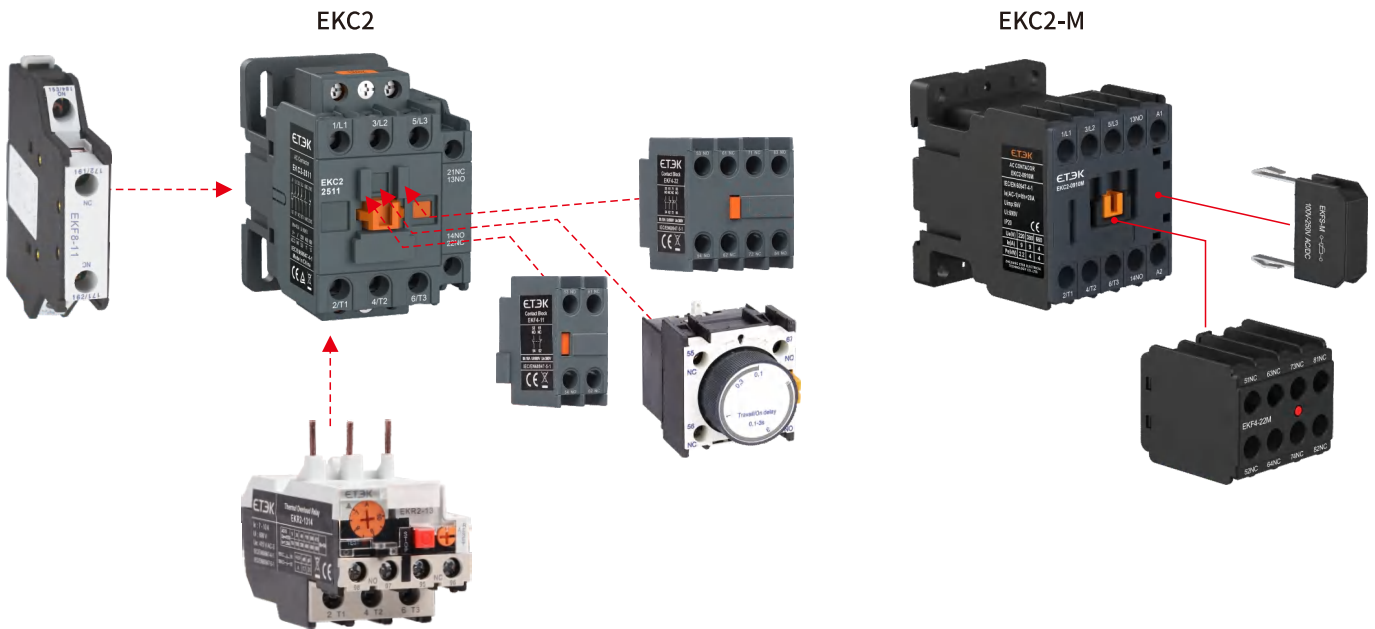



Description

EKQ1 series electromagnetic starter ("starter" for short hereinafter) applies mainly to circuit with AC current of 50Hz(or 60Hz), rated operational voltage of 660V and rated controlled power up to 45kW (current up to 95A) for using to control the direct start and halt of the electromotor to protect the motor from overload and phase failure.

Type Designation

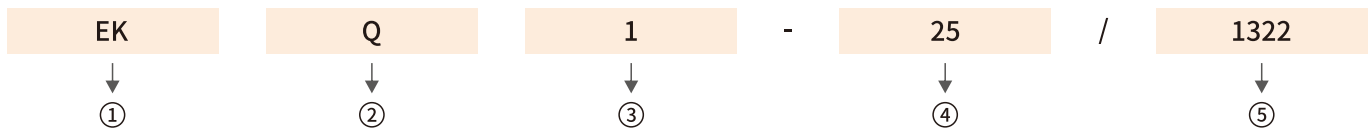

Code	Meaning
①	Company code
②	DOL Electromagnetic Starter
③	Design sequence Number

Code	Meaning
④	Frame Size
⑤	Code of Thermal Overload Relay CR2

Wiring Diagram

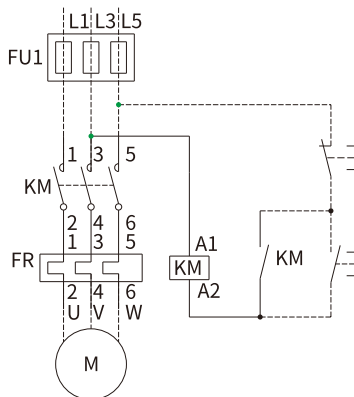

Control supply voltage is as the same as the main circuit voltage (three-phase)

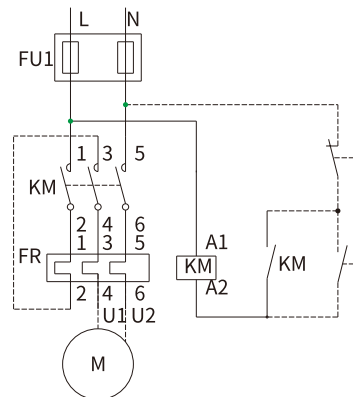

Control supply voltage is as the same as the main circuit voltage (single-phase)

Basic Model and Main Technical Parameter of The Starter

Model	Range of setting current (A)	Current (A)	Maximum rated Power (kW)			Model of equipped AC contactor	TOR matched
			AC-3				
			600V	380V	220V		
EKQ1-09/1301	0.1~0.16	9	5.5	4	2.2	EKC1/EKC2(S)-09	EKR2-13
EKQ1-09/1302	0.16~0.25						
EKQ1-09/1303	0.25~0.4						
EKQ1-09/1304	0.4~0.63						
EKQ1-09/1305	0.63~1						
EKQ1-09/1306	1~1.6						
EKQ1-09/1307	1.6~2.5						
EKQ1-09/1308	2.5~4						
EKQ1-09/1310	4~6						
EKQ1-09/1312	5.5~8						
EKQ1-09/1314	7~10	18	10	7.5	4	EKC1/EKC2(S)-18	EKR2-13
EKQ1-18/1316	9~13						
EKQ1-18/1321	12~18						
EKQ1-25/1321	12~18	25	15	11	5.5	EKC1/EKC2(S)-25	EKR2-13
EKQ1-25/1322	17~25						
EKQ1-32/2353	23~32	32	18.5	15	7.5	EKC1/EKC2(S)-32	EKR2-23
EKQ1-40/3355	30~40	40	30	18.5	11	EKC1/EKC2(S)-40	EKR2-33
EKQ1-50/3357	37~50	50	33	22	15	EKC1/EKC2(S)-50	EKR2-33
EKQ1-65/3359	48~65	65	37	30	18.5	EKC1/EKC2(S)-65	EKR2-33
EKQ1-80/3361	55~70	80	45	37	22	EKC1/EKC2(S)-80	EKR2-33
EKQ1-80/3363	63~80						
EKQ1-95/3365	80~93	95	45	45	25	EKC1/EKC2(S)-95	EKR2-33

Dimension(mm)

EKQ1-09~32(Steel base + Plastic cover)

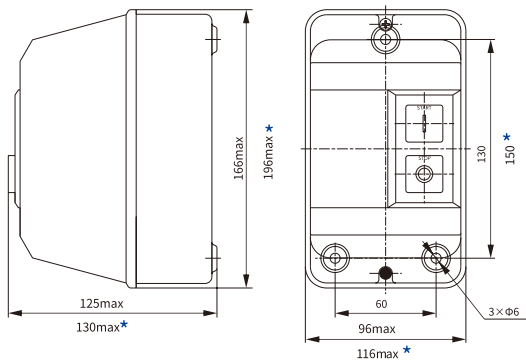

EKQ1-40~95(Steel base + Steel cover)

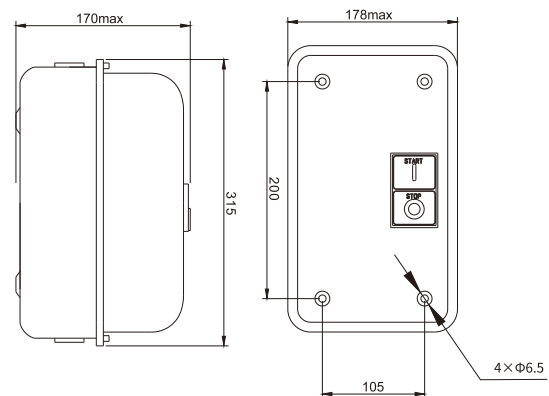

Note: Dimension with * for EKQ1-25~32



EKQ1-09/18



EKQ1-25/32



EKQ1-40~95

Description

EKQ2 series magnetic starter is suitable for using in the circuits the rated voltage up to 660V, AC 50Hz or 60Hz, rated control power to 45kW and current to 95A. It is used to control the direct start and stop of the motor, and the starter with thermal overload relay protects the motor from overload and phase failure.

Standard: IEC/EN 60947-4-1.

Type Designation

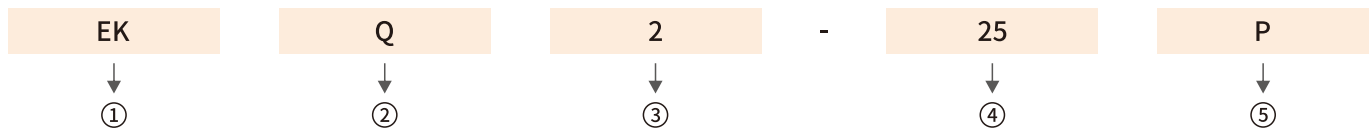

Code	Meaning
①	Company code
②	DOL Electromagnetic Starter
③	Design sequence Number

Code	Meaning
④	Current degree
⑤	Design code: P: Push button; H: Button with lamp

Operation and Installation Condition

- Altitude: ≤2000m.
- Ambient air temperature: -5°C~+40°C, average temperature of 24 hours must below+35°C.
- Relative humidity: the maximum temperature of 40 degrees, the air relative humidity not exceed 50%, at a lower temperature can allow for a higher relative humidity. The wettest month' s average lowest temperature must be below 25°C, the max relative humidity of that month should not exceed 90%. If humidity changes as a result of occasional gel generated, should eliminate it.
- Installation position: The installation degree of the tilt and vertical plane should not exceed 5°.
- In a non-explosive hazardous medium, and there is no place in the medium that is sufficient to corrode metals and destroy insulation gases and conductor dust.
- Where there is rain and snow protection and there is no steam.
- Shock vibration: Products should be installed and used without severe shake, shock and vibration of the place.

Specifications

- Specifications for magnetic starter (sheet1)
- Coil rated control power supply voltage Us can be divided into AC 50Hz or 60Hz: 36V, 110V, 220V, 380V.
- Operating condition: Coil pull-in voltage is (85%~110%) Us; Release voltage is (20%~75%) Us.

Table 1

Type	Rated current Ie A	Maximum power duty (kW)			Matched AC contactor type	Matched thermal relay	Setting current range (A)
		AC-3					
		660V	380V	220V			
EKQ2-09	9	5.5	4	2.2	EKC1/EKC2S-09	EKR2-13	0.1~0.16, 0.16~0.25 0.25~0.4, 0.4~0.63 0.63~1, 1~1.6 1.25~2, 1.6~2.5 2.5~4, 4~6, 5.5~8
EKQ2-12	12	7.5	5.5	3	EKC1/EKC2S-12		7~10, 9~13
EKQ2-18	18	10	7.5	4	EKC1/EKC2S-18		12~18
EKQ2-25	25	15	11	5.5	EKC1/EKC2S-25		17~25
EKQ2-32	32	18.5	15	7.5	EKC1/EKC2S-32	EKR2-23	23~32
EKQ2-40	40	18.5	18.5	11	EKC1/EKC2S-40	EKR2-33	23~32, 30~40 37~50, 48~65 55~70, 63~80 80~93
EKQ2-50	50	22	22	15	EKC1/EKC2S-50		
EKQ2-65	65	30	30	18.5	EKC1/EKC2S-65		
EKQ2-80	80	37	37	22	EKC1/EKC2S-80		
EKQ2-95	95	45	45	25	EKC1/EKC2S-95		

Structural Features

The starter adopts a protective structure with a protective cover of IP55 and is internally composed of a EKC2S AC contactor and a EKR2 thermal overload relay. The entry and exit wiring of the starter adopts the knockout type wiring hole, and the user can selectively knock and connect the four knockout holes according to the wiring requirements. The cover and the base of the starter can be completely separated, and the user is very convenient to install and maintain; the button adopts the EKP2 series push button switch assembly to realize the start and stop of the starter, and it will be safe and reliable.

In order to improve the protective performance of the starter, the starter must be installed vertically. The mounting screws should be selected according to the size of the mounting hole. The screws should be no less than M5, and spring washers, flat washers and sealing rubber rings should be added to ensure the fastening of the starter. In addition, the knockout terminal holes should be equipped with corresponding waterproof terminals.

Dimension(mm)

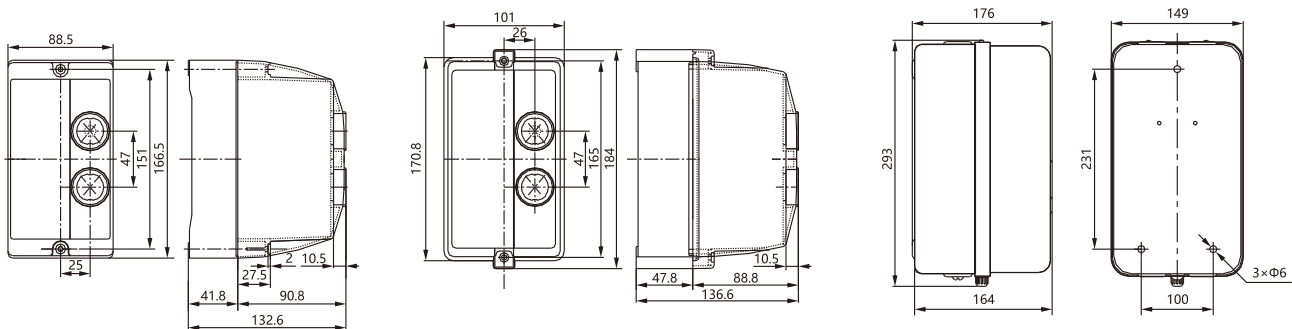

EKQ2-09~18

EKQ2-25~32

EKQ2-40~95

EKMS2 MPCB



Motor Protection Circuit Breaker

Standard_ IEC60947-2
IEC60947-4-1



EKMS2-32



EKMS2-32P



EKMS2-32R



EKMS2-80



EKMS2-80P

Description

- Electric value: AC690V, 32A, 80A;
- Standard: IEC/EN 60947-2, IEC60947-4-1

Type Designation

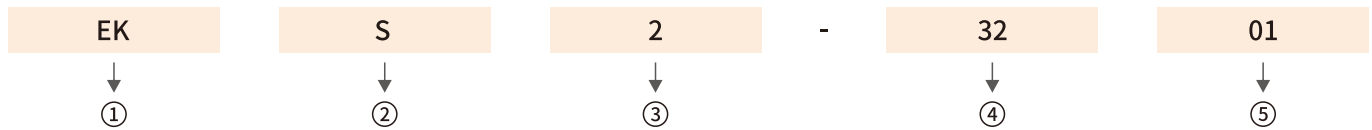

Code	Meaning
①	Company code
②	AC motor starter
③	Design sequence Number

Code	Meaning
④	Frame Size rated current (A)
⑤	Code of rated current

Operating Condition

Temperature	-5°C~+40°C, average temperature in 24 hours not exceed +35°C
Altitude	not exceed 2000m
Air conditions	At mounting site, relative humidity not exceed 50% at the max temperature of +40°C, higher relative humidity is allowable under lower temperature, for example, RH could be 90% at +20°C.
Pollution grade	Grade III
Release grade	10A(CS2-32); 10A(CS2-80)
Rated operational system	Continuous operational system
Mounting conditions	The inclination between the mounting plane and the vertical plane shall not exceed 5°; The product shall be installed and operated at a place without obvious shake, Impact and vibration.

Technical Data

Over-load protection properties

Series No.	Multiple of setting current	Initial status	Time	Expected results	Ambient temperature
1	1.05	Cold status	$t \geq 2h$	Non-tripping	$+20^{\circ}C \pm 2^{\circ}C$
2	1.20	Heat status (right after test.1)	$t < 2h$	Tripping	$+20^{\circ}C \pm 2^{\circ}C$
3	1.50	Heat status (right after test.1)	Tripping class 10A $t < 2min$ 10 $t < 4min$	Tripping	$+20^{\circ}C \pm 2^{\circ}C$
4	7.20	Cold status	Tripping class 10A $2s < t \leq 10s$ 10 $4s < t \leq 10s$	Tripping	$+20^{\circ}C \pm 2^{\circ}C$

Phase failure protection properties

Series No.	Multiple of setting current		Initial status	Time	Expected results	Ambient temperature
	Any 2 phase	The other phase				
1	1.0	0.9	Cold status	$t \geq 2h$	Non-tripping	$+20^{\circ}C \pm 2^{\circ}C$
2	1.15	0	Heat status (right after test.1)	$t < 2h$	Tripping	$+20^{\circ}C \pm 2^{\circ}C$

Temperature compensation properties

Series No.	Multiple of setting current	Initial status	Time	Expected results	Ambient temperature
1	1.0	Cold status	$t \geq 2h$	Non-tripping	$+40^{\circ}C \pm 2^{\circ}C$
2	1.2	Heat status (right after test.1)	$t < 2min$	Tripping	$+40^{\circ}C \pm 2^{\circ}C$
3	1.05	Cold status	$t \geq 2h$	Non-tripping	$-50^{\circ}C \pm 2^{\circ}C$
4	1.3	Heat status (right after test.1)	$t < 2min$	Tripping	$-50^{\circ}C \pm 2^{\circ}C$

Model of overload relay	Code	Rated current (A)	Rated ultimate short-circuit breaking capacity Icu(kA)			Rated service short-circuit breaking capacity Ics(kA)			Standard rated power of three-phase motor (kW)		
			230/240V	400/415V	660/690V	230/240V	400/415V	660/690V	230/240V	400/415V	660/690V
EKMS2-32	3201	0.1~0.16	100	100	100	100	100	100	-	-	-
	3202	0.16~0.25	100	100	100	100	100	100	-	-	-
	3203	0.25~0.4	100	100	100	100	100	100	-	-	-
	3204	0.4~0.63	100	100	100	100	100	100	-	-	0.37
	3205	0.63~1	100	100	100	100	100	100	-	-	0.55
	3206	1~1.6	100	100	100	100	100	100	-	-	1.1
	3207	1.6~2.5	100	100	3	100	100	2.25	0.37	0.75	1.5
	3208	2.5~4	100	100	3	100	100	2.25	0.75	1.5	3
	3210	4~6.3	100	100	3	100	100	2.25	1.1	2.2	4
	3214	6~10	100	100	3	100	100	2.25	2.2	4	7.5
	3216	9~14	100	15	3	100	7.5	2.25	3	5.5	9
	3220	13~18	100	15	3	100	7.5	2.25	4	9	11
	3221	17~23	50	15	3	50	6	2.25	5.5	11	15
3222	20~25	50	15	3	50	6	2.25	5.5	11	18.5	
3232	24~32	50	15	3	50	6	2.25	7.5	12.5	22	
EKMS2-80	8025	16~25	-	15	-	-	7.5	-	5.5	11	-
	8040	25~40	-	15	-	-	7.5	-	11	22	-
	8063	40~63	-	15	-	-	7.5	-	15	33	-
	8080	56~80	-	15	-	-	7.5	-	22	45	-

Accessories

Under-Voltage Release



Rated insulation voltage Ui(V)	Voltage range of operation	Model	Specification
690	35%~70%Ue	EKMS2-UV110	110~115V 50Hz
690	35%~70%Ue	EKMS2-UV127	127V 60Hz
690	35%~70%Ue	EKMS2-UV220	220~240V 50Hz
690	35%~70%Ue	EKMS2-UV380	380~400V 50Hz
690	35%~70%Ue	EKMS2-UV440	440V 60Hz

Shunt Release



Rated insulation voltage Ui(V)	Voltage range of operation	Model	Specification
690	70%~110%Ue	EKMS2-SH110	110~115V 50Hz
690	70%~110%Ue	EKMS2-SH127	127V 60Hz
690	70%~110%Ue	EKMS2-SH220	220~240V 50Hz
690	70%~110%Ue	EKMS2-SH380	380~400V 50Hz
690	70%~110%Ue	EKMS2-SH440	440V 60Hz

Instantaneous auxiliary contact



Rated insulation voltage Ui(V)	Conventional heating current Ith(A)	Model	Configuration
250	2.5	EKMS2-AE20	2NO
250	2.5	EKMS2-AE11	1NO+1NC

EKMS2-AN20 EKMS2-AN11 EKMS2-AU20 EKMS2-AU11



Rated insulation voltage Ui(V)	Conventional heating current Ith(A)	Model	Configuration	Starter matched
690	6	EKMS2-AN20	2NO	EKMS2-32
690	6	EKMS2-AN11	1NO+1NC	
690	6	EKMS2-AU20	2NO	EKMS2-80
690	6	EKMS2-AU11	1NO+1NC	

Fault signal contact and instantaneous auxiliary contact



Rated insulation voltage Ui(V)	Conventional heating current Ith(A)		Model	Configuration
	Instantaneous auxiliary contact	Fault signal contact		
690	6	2.5	EKMS2-FA0110	1NC+1NO
690	6	2.5	EKMS2-FA0101	1NC+1NC
690	6	2.5	EKMS2-FA1010	1NO+1NO
690	6	2.5	EKMS2-FA1001	1NO+1NC

Application class, rated operational voltage and tated operational current of instantaneous auxiliary contact

Utilization category	AC-15				DC-13		
	24	48	110/127	230/240	24	48	60
Rated operational voltage Ue(V)	24	48	110/127	230/240	24	48	60
Rated operational current Ie(A)	2	1.25	1	0.5	1	0.3	0.15
Normal operational power P(W)	48	60	127	120	24	15	9



EKMS2-MC Installation box without pushbutton

IP55

Dimension(mm)

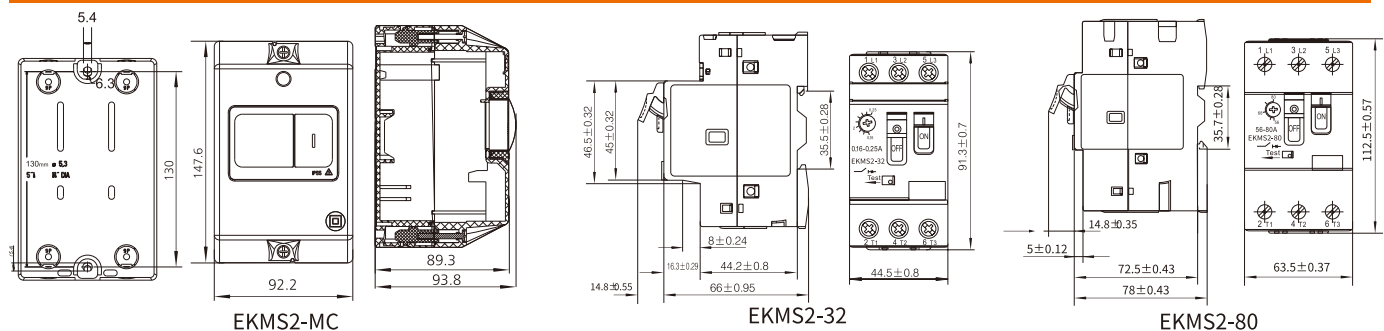

LED INDICATOR

Application

EKLD series indicator light are used in the telecommuni-cation and electrical circuit of AC 50Hz or 60Hz, rated working voltage 380V and below DC working voltage 220V or below for indicator signal, accident signal, fault signal and other indicator signals, they meet with the standard: IEC60947-5-1.

Structure and Function

EKLD series indicator lights adopt LED lamp with the characteristic of long life and low energy consumption, its concealed terminal is both safe and creditable. The special locking nut structure makes the installation available in the dimension of EKLD-22: φ22.5 mm to φ25.5mm, EKLD-16: φ16.5 mm to φ16.5mm.



ELECTRIC

Schematic Diagram

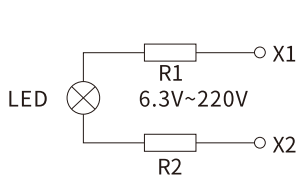

Resistance

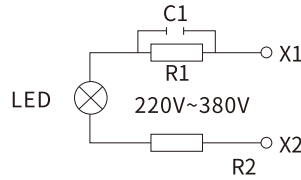

Anti-interference type

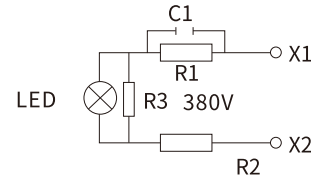

Discharge Lamp

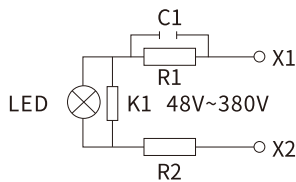

Anti-interference Lamp

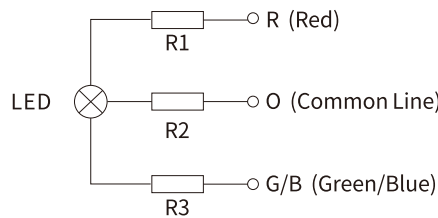



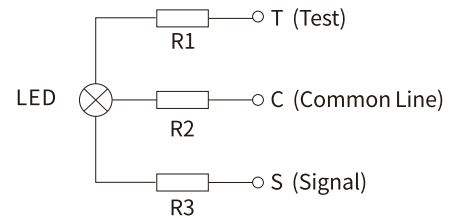





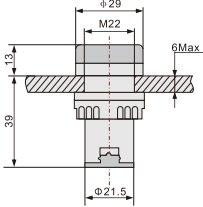

Double color

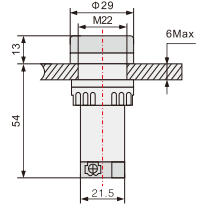

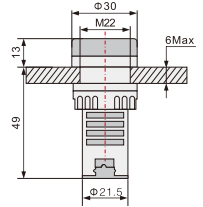
Lamp Test Type

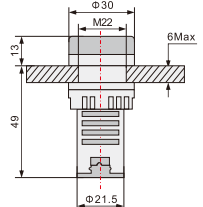
Man Technical Parameter

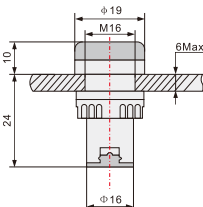
Operation temperature: -5°C~+40°C	Power-frequency withstand voltage: 2500V, min
Operation humidity: 45%~85%	Installation degree: III
Pollution degree: 3	Degree of protection: IP65
Rated operation voltage	(Ue) AC/DC 9V AC/DC 12V AC/DC 24V AC/DC 48V AC/DC 110V AC/DC 220V AC 380V
Rated operation current	(Ie) ≤80mA ≤20mA
Base colour	Green Yellow Red Blue White
Electrical Life(h)	≥3000
Brightness	60

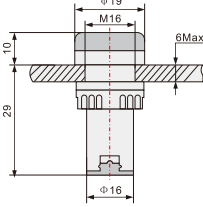
Indicator	Description	Voltage	Color	Type	Outline Dimensions
	Protected LED Indicator φ 22	6.3V AC/DC	● Red	EKLD-22DS	
		12V AC/DC	● Yellow	General type	
		24V AC/DC	● Green	EKLD-22DKS	
		48V AC/DC	● Blue	Anti-interference type	
		110V AC/DC	● White	EKLD-22DFS	
		220V AC/DC		Discharge Lamp	
	380V AC				
	Protected LED Indicator Double color φ 22	6.3V AC/DC	● Red	EKLD-22DRG	
		12V AC/DC	● Green		
		24V AC/DC			
		48V AC/DC			
		110V AC/DC	● Red	EKLD-22DRB	
		220V AC/DC	● Blue		
	380V AC				
	Protected LED Indicator Buzzer φ 22	6.3V AC/DC	● Red	EKLD-22MSD	
		12V AC/DC		Flash buzzer type	
		24V AC/DC			
		48V AC/DC			
		110V AC/DC	● Black	EKLD-22MFD	
		220V AC/DC		Buzzer type	
	380V AC				
	Protected LED Indicator Lamp Test Type φ 22	6.3V AC/DC	● Red	EKLD-22DLT	
		12V AC/DC	● Yellow		
		24V AC/DC	● Green		
		48V AC/DC	● Blue		
		110V AC/DC	● White		
		220V AC/DC			
	380V AC				
	Protected LED Indicator φ 16	6.3V AC/DC	● Red	EKLD-16DS	
		12V AC/DC	● Yellow		
		24V AC/DC	● Green		
		48V AC/DC	● Blue		
		110V AC/DC	● White		
		220V AC/DC			
	380V AC				
	Protected LED Indicator φ 16	6.3V AC/DC	● Red	EKLD-16D	
		12V AC/DC	● Yellow		
		24V AC/DC	● Green		
		48V AC/DC	● Blue		
		110V AC/DC	● White		
		220V AC/DC			
	380V AC				

Type Designation

EKLV22					① Digital display meter model
↓	↓	↓	↓	↓	② R means round, S means square
①	②	③	④		③ A means AC, D means DC
					④ V means voltage meter

Summary

Mini digital display voltage meter

EKLV22 series products two-wire three-way AC, DC digital display voltage meter.

- Products use 2.5 inches long life LED digital tube display with compact square enclosure, convenient installation.
- Products measurement range AC 80V-500V, DC 5-120V, frequency 50/60Hz.
- Products use two wire system, AC connected in zero line and fire line directly,
- DC have polarity reverse connection protection function.







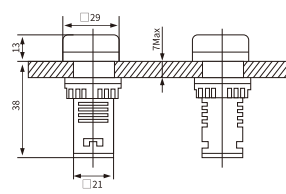

Working Condition

- Ambient temperature: -10 ~ +55°C
- Air relative humidity: 10-80%(no condensation)
- Working pressure: 80-106KPa
- Sunniness: no sunniness

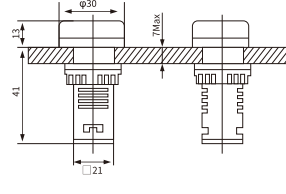
Technical parameter

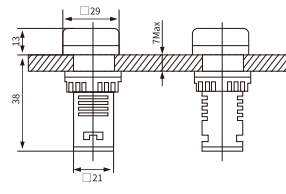
- Working voltage: AC 80-500V, DC 8-150V
- Working frequency: 50/60Hz
- Working current: ≤20MA
- Measuring accuracy: 1.0
- Measuring rate: <200MS/time
- Mounting-hole size: φ22mm

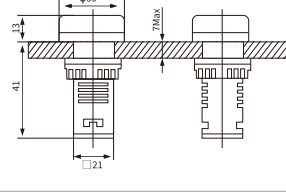
Style	Name	Type	Color	Voltage	Outine Dimensions
	φ22 LED Voltage Meter	EKLV22-RAV	<ul style="list-style-type: none"> ○ White ● Green ● Red ● Yellow ● Blue 	AC80-500V	
	φ22 LED Voltage Meter	EKLV22-SAV	<ul style="list-style-type: none"> ○ White ● Green ● Red ● Yellow ● Blue 	AC80-500V	
	φ22 LED Voltage Meter	EKLV22-RDV	<ul style="list-style-type: none"> ○ White ● Green ● Red ● Yellow ● Blue 	DC5-120V	
	φ22 LED Voltage Meter	EKLV22-SDV	<ul style="list-style-type: none"> ○ White ● Green ● Red ● Yellow ● Blue 	DC5-120V	

Pushbutton Switch

Application

EKPB2-series pushbutton switches are used in industrial for controlling circuits of AC 50Hz or 60Hz, rated operation voltage 380V or below and DC operational Voltage 220V or below for controlling in magnetic starter, contactor, relay and other electrical circuits. The buttons indicators can also be used in the place with indicated light or signal. They meet with the standards :IEC60947-5-1.



Main Technical Parameter





Operation temperature	-5°C~+40°C					
Power-frequency withstand voltage	2500V, 1min					
Operation humidity	45%~85%					
Electric durability	50×10 ⁴					
Contact resistance	≤50mΩ					
Degree of protection	IP40					
Rated insulation voltage	Ui	660V				
Conventional thermal current	Ith	10A				
Rated operation voltage	Ue	380V	220V	110V	48V	24V
Rated operation current	AC-15	2.5A	4.5	6A	8A	—
	DC-13	—	0.3A	0.6A	1.3A	2.5

Rated operational Voltage	Directness						Resistance		Transformer	
	6V	12V	24V	48V	110V	220V	380V	220V	220V	380V
LED lamp	√	√	√	—	—	—	—	—	√	√
Neon lamp	—	—	—	—	√	√	√	√	—	—
Incandescence lamp	√	√	√	√	√	√	√	—	√	√

EKPB2

Pushbutton Switch (φ22mm)





Standard_IEC60947-5-1

Plastic Type	Description	Type	Scheme	color
	Flush button spring return	EKPB2-EA11	NO	○ White
		EKPB2-EA21	NO	● Black
		EKPB2-EA31	NO	● Green
		EKPB2-EA51	NO	● Yellow
		EKPB2-EA61	NO	● Blue
		EKPB2-EA42	NC	● Red
		EKPB2-EA25	NO+NC	● Black
		EKPB2-EA35	NO+NC	● Green
		EKPB2-EA45	NO+NC	● Red
	Button with protective cover IP65	EKPB2-EP11	NO	○ White
		EKPB2-EP21	NO	● Black
		EKPB2-EP31	NO	● Green
		EKPB2-EP51	NO	● Yellow
		EKPB2-EP61	NO	● Blue
		EKPB2-EP42	NC	● Red
		EKPB2-EP25	NO+NC	● Black
		EKPB2-EP35	NO+NC	● Green
		EKPB2-EP45	NO+NC	● Red
	Protruding button	EKPB2-EL11	NO	○ White
		EKPB2-EL21	NO	● Black
		EKPB2-ELP31	NO	● Green
		EKPB2-EL51	NO	● Yellow
		EKPB2-EL61	NO	● Blue
		EKPB2-EL42	NC	● Red
		EKPB2-EL25	NO+NC	● Black
		EKPB2-EL35	NO+NC	● Green
		EKPB2-EL45	NO+NC	● Red
	Standard handle knob	EKPB2-ED21	NO	∨
		EKPB2-ED25	NO+NC	∨
		EKPB2-ED41	NO	∨
		EKPB2-ED45	NO+NC	∨
		EKPB2-ED33	2NO	∨
		EKPB2-ED53	2NO	∨
	Long handle knob	EKPB2-EJ21	NO	∨
		EKPB2-EJ25	NO+NC	∨
		EKPB2-EJ41	NO	∨
		EKPB2-EJ45	NO+NC	∨
		EKPB2-EJ33	2NO	∨
		EKPB2-EJ53	2NO	∨

EKPB2

Pushbutton Switch ($\phi 22\text{mm}$)

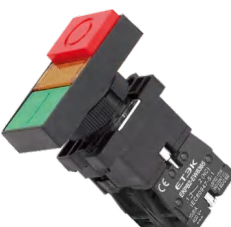



Standard_IEC60947-5-1

Plastic Type	Description	Type	Scheme	color
	Key button	EKPB2-EG21	NO	
		EKPB2-EG25	NO+NC	
		EKPB2-EG41	NO	
		EKPB2-EG45	NO+NC	
		EKPB2-EG61	NO	
		EKPB2-EG65	NO+NC	
		EKPB2-EG03	2NO	
		EKPB2-EG33	2NO	
		EKPB2-EG53	2NO	
EKPB2-EG73	2NO			
	Double head button	EKPB2-EL8325	NO+NC	
		EKPB2-EL8425	NO+NC	
	Double head button with lamp 6V~380V	EKPB2-EW8365 (Directness)	NO+NC	
		EKPB2-EW8465 (Directness)	NO+NO	
		EKPB2-EW8375 (Resistance)	NO+NC	
		EKPB2-EW8475 (Resistance)	NO+NC	
	Mushroom button spring return	$\phi 40$ EKPB2-EC21	NO	
		$\phi 40$ EKPB2-EC31	NO	
		$\phi 40$ EKPB2-EC42	NC	
		$\phi 40$ EKPB2-EC51	NO	
		$\phi 60$ EKPB2-ER21	NO	
		$\phi 60$ EKPB2-ER31	NO	
		$\phi 60$ EKPB2-ER42	NC	
$\phi 60$ EKPB2-ER52	NO			
	Mushroom rotation auto-reset emergency button	$\phi 30$ EKPB2-ES442	NC	
		$\phi 40$ EKPB2-ES542	NC	
		$\phi 60$ EKPB2-ES642	NC	

EKPB2

Pushbutton Switch (φ22mm)

Standard_IEC60947-5-1

Plastic Type	Description	Type	Scheme	color
	Push and pull type emergency button	φ40 EKPB2-ET42	NC	● Red
		φ40 EKPB2-ET845	NO+NC	● Red
	Mushroom rotation auto-reset emergency button with key	φ40 EKPB2-ES142	NC	● Red
		φ40 EKPB2-ES8445	NO+NC	● Red
	Indicator light 6V~380V	Directness EKPB2-EV61		○ White
		Directness EKPB2-EV63		● Green
		Directness EKPB2-EV64		● Red
		Directness EKPB2-EV65		● Yellow
		Directness EKPB2-EV66		● Blue
		Resistance EKPB2-EV71		○ White
		Resistance EKPB2-EV73		● Green
		Resistance EKPB2-EV74		● Red
Resistance EKPB2-EV75		● Yellow		
Resistance EKPB2-EV76		● Blue		
	Flush button with lamp Directness 6V~380V	EKPB2-EW3161	NO	○ White
		EKPB2-EW3361	NO	● Green
		EKPB2-EW3462	NC	● Red
		EKPB2-EW3561	NO	● Yellow
		EKPB2-EW3661	NO	● Blue
		EKPB2-EW3365	NO+NC	● Green
		EKPB2-EW3465	NO+NC	● Red
	For making up body assemblies with 3, 4,5 or maximum of 6 contact blocks or replacing 1 st or and contact	EKPB2-EZ101	NO	● Green
		EKPB2-EZ103	NO+NO	● Green
		EKPB2-EZ105	NO+NC	● Green ● Red
		EKPB2-EZ102	NC	● Red
		EKPB2-EZ104	NC+NC	● Red ● Red

EKPB2

Pushbutton Switch (φ22mm)



Standard_IEC60947-5-1

Metal Type	Description	Type	Scheme	color
	Flush button spring return	EKPB2-BA11	NO	○ White
		EKPB2-BA21	NO	● Black
		EKPB2-BA31	NO	● Green
		EKPB2-BA51	NO	● Yellow
		EKPB2-BA61	NO	● Blue
		EKPB2-BA42	NC	● Red
		EKPB2-BA25	NO+NC	● Black
		EKPB2-BA35	NO+NC	● Green
		EKPB2-BA45	NO+NC	● Red
	Button with protective cover IP65	EKPB2-BP11	NO	○ White
		EKPB2-BP21	NO	● Black
		EKPB2-BP31	NO	● Green
		EKPB2-BP51	NO	● Yellow
		EKPB2-BP61	NO	● Blue
		EKPB2-BP42	NC	● Red
		EKPB2-BP25	NO+NC	● Black
		EKPB2-BP35	NO+NC	● Green
		EKPB2-BP45	NO+NC	● Red
	Protruding button	EKPB2-BL11	NO	○ White
		EKPB2-BL21	NO	● Black
		EKPB2-BLP31	NO	● Green
		EKPB2-BL51	NO	● Yellow
		EKPB2-BL61	NO	● Blue
		EKPB2-BL42	NC	● Red
		EKPB2-BL25	NO+NC	● Black
		EKPB2-BL35	NO+NC	● Green
		EKPB2-BL45	NO+NC	● Red
	Standard handle knob	EKPB2-BD21	NO	↘
		EKPB2-BD25	NO+NC	↘
		EKPB2-BD41	NO	↘
		EKPB2-BD45	NO+NC	↘
		EKPB2-BD33	2NO	↘
		EKPB2-BD53	2NO	↘
	long handle knob	EKPB2-BJ21	NO	↘
		EKPB2-BJ25	NO+NC	↘
		EKPB2-BJ41	NO	↘
		EKPB2-BJ45	NO+NC	↘
		EKPB2-BJ33	2NO	↘
		EKPB2-BJ53	2NO	↘

EKPB2

Pushbutton Switch ($\phi 22\text{mm}$)

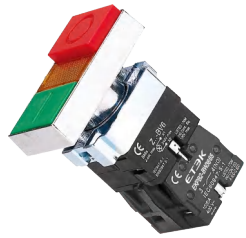



Standard_IEC60947-5-1

Metal Type	Description	Type	Scheme	color
	Key button	EKPB2-BG21	NO	
		EKPB2-BG25	NO+NC	
		EKPB2-BG41	NO	
		EKPB2-BG45	NO+NC	
		EKPB2-BG61	NO	
		EKPB2-BG65	NO+NC	
		EKPB2-BG03	2NO	
		EKPB2-BG33	2NO	
		EKPB2-BG53	2NO	
EKPB2-BG73	2NO			
	Double head button	EKPB2-BL8325	NO+NC	
		EKPB2-BL8425	NO+NC	
	Double head button with lamp 6V~380V	EKPB2-BW8365 (Directness)	NO+NC	
		EKPB2-BW8465 (Directness)	NO+NO	
		EKPB2-BW8375 (Resistance)	NO+NC	
		EKPB2-BW8475 (Resistance)	NO+NC	
	Mushroom button spring return	$\phi 40$ EKPB2-BC21	NO	
		$\phi 40$ EKPB2-BC31	NO	
		$\phi 40$ EKPB2-BC42	NC	
		$\phi 40$ EKPB2-BC51	NO	
		$\phi 60$ EKPB2-BR21	NO	
		$\phi 60$ EKPB2-BR31	NO	
		$\phi 60$ EKPB2-BR42	NC	
$\phi 60$ EKPB2-BR52	NO			
	Mushroom rotation auto-reset emergency button	$\phi 30$ EKPB2-BS442	NC	
		$\phi 40$ EKPB2-BS542	NC	
		$\phi 60$ EKPB2-BS642	NC	

EKPB2

Pushbutton Switch (φ22mm)

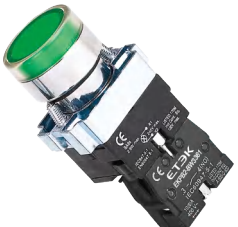
Standard_IEC60947-5-1

Metal Type	Description	Type	Scheme	color
	Push and pull type emergency button	φ40 EKPB2-BT42	NC	● Red
		φ40 EKPB2-BT845	NO+NC	● Red
	Mushroom rotation auto-reset emergency button with key	φ40 EKPB2-BS142	NC	● Red
		φ40 EKPB2-BS8445	NO+NC	● Red
	Indicator light 6V~380V	Directness EKPB2-BV61		○ White
		Directness EKPB2-BV63		● Green
		Directness EKPB2-BV64		● Red
		Directness EKPB2-BV65		● Yellow
		Directness EKPB2-BV66		● Blue
		Resistance EKPB2-BV71		○ White
		Resistance EKPB2-BV73		● Green
		Resistance EKPB2-BV74		● Red
Resistance EKPB2-BV75		● Yellow		
Resistance EKPB2-BV76		● Blue		
	Flush button with lamp Directness 6V~380V	EKPB2-BW3161	NO	○ White
		EKPB2-BW3361	NO	● Green
		EKPB2-BW3462	NC	● Red
		EKPB2-BW3561	NO	● Yellow
		EKPB2-BW3661	NO	● Blue
		EKPB2-BW3365	NO+NC	● Green
		EKPB2-BW3465	NO+NC	● Red
	2-Position Knob lamp 6V~380V	EKPB2-BK2365	NO+NC	● Green
		EKPB2-BK2465	NO+NC	● Red
	3-Position Knob lamp 6V~380V	EKPB2-BK3365	NO+NC	● Green
		EKPB2-BK3465	NO+NC	● Red

EKPB2





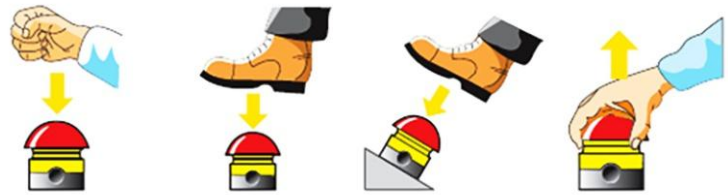
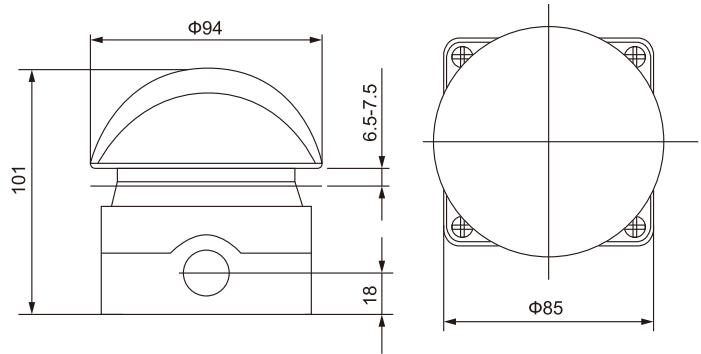

Pushbutton Switch (φ22mm) ----- Standard_IEC60947-5-1







Metal Type	Description	Type	Scheme	color
	For making up body assemblies with 3, 4,5 or maximum of 6 contact blocks or replacing 1 st or and contact	EKPB2-BZ101	NO	● Green
		EKPB2-BZ103	NO+NO	● Green
		EKPB2-BZ105	NO+NC	● Green ● Red
		EKPB2-BZ102	NC	● Red
		EKPB2-BZ104	NC+NC	● Red ● Red
	Bottombase seat ofbutton with lamp Direct Type Neon(BA9S) LED	EKPB2-BV6	Without bracket	
		EKPB2-BW06	With bracket	
	Bracket	EKPB2-BZ009	Bracket	
	For making up body assemblies with 3, 4,5 or maximum of 6 contact blocks or replacing 1 st or and contact	EKPB2-BE102	NC	● Red
	For making up body assemblies with 3, 4,5 or maximum of 6 contact blocks or replacing 1 st or and contact	EKPB2-BE101	NO	● Green









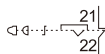



























Foot pedal switch Series

Auxiliary contact: o=positive open safety function, in accordance with IEC/EN60947-5-1	M=normally open	B=normally closed	Contact number	Color of mushroom head
Spring reset				
<ul style="list-style-type: none"> The top of the shell is grey The bottom of the shell is black 	1M	1B \ominus		Black \bullet
	2M	0B \ominus		Red \bullet
	0M	2B \ominus		Green \bullet
	2M	1B \ominus		Yellow \bullet
<ul style="list-style-type: none"> The top of the shell is Yellow The bottom of the shell is grey 	1M	1B \ominus		Black \bullet
	2M	0B \ominus		Red \bullet
	0M	2B \ominus		Green \bullet
	2M	1B \ominus		Yellow \bullet
<ul style="list-style-type: none"> Self-locking The top of the shell is Yellow The bottom of the shell is black Pull reset 		1B \ominus		Red \bullet
	1M	1B \ominus		Red \bullet
		2B \ominus		Red \bullet
Pull reset				

Pictures	Reference No.	Specification
 	EKPBM-BGB11	Pushbutton Spring Return type Black head Gray/Black base 1NO+1NC
	EKPBM-RGB11	Pushbutton Spring Return type Red head Gray/Black base 1NO+1NC
	EKPBM-YGB11	Pushbutton Spring Return type Yellow head Gray/Black base 1NO+1NC
	EKPBM-GGB11	Pushbutton Spring Return type Green head Gray/Black base 1NO+1NC
	EKPBM-BGB20	Pushbutton Spring Return type Black head Gray/Black base 2NO
	EKPBM-RGB20	Pushbutton Spring Return type Red head Gray/Black base 2NO
	EKPBM-YGB20	Pushbutton Spring Return type Yellow head Gray/Black base 2NO
	EKPBM-GGB20	Pushbutton Spring Return type Green head Gray/Black base 2NO
	EKPBM-BGB02	Pushbutton Spring Return type Black head Gray/Black base 2NC
	EKPBM-RGB02	Pushbutton Spring Return type Red head Gray/Black base 2NC
	EKPBM-YGB02	Pushbutton Spring Return type Yellow head Gray/Black base 2NC
	EKPBM-GGB02	Pushbutton Spring Return type Green head Gray/Black base 2NC
	EKPBM-BGB21	Pushbutton Spring Return type Black head Gray/Black base 2NO+1NC
	EKPBM-RGB21	Pushbutton Spring Return type Red head Gray/Black base 2NO+1NC
	EKPBM-YGB21	Pushbutton Spring Return type Yellow head Gray/Black base 2NO+1NC
	EKPBM-GGB21	Pushbutton Spring Return type Green head Gray/Black base 2NO+1NC
	EKPBM-BGB12	Pushbutton Spring Return type Black head Gray/Black base 1NO+2NC
	EKPBM-RGB12	Pushbutton Spring Return type Red head Gray/Black base 1NO+2NC
	EKPBM-YGB12	Pushbutton Spring Return type Yellow head Gray/Black base 1NO+2NC
	EKPBM-GGB12	Pushbutton Spring Return type Green head Gray/Black base 1NO+2NC
	EKPBM-BGB30	Pushbutton Spring Return type Black head Gray/Black base 3NO
EKPBM-RGB30	Pushbutton Spring Return type Red head Gray/Black base 3NO	
EKPBM-YGB30	Pushbutton Spring Return type Yellow head Gray/Black base 3NO	
EKPBM-GGB30	Pushbutton Spring Return type Green head Gray/Black base 3NO	
EKPBM-BGB03	Pushbutton Spring Return type Black head Gray/Black base 3NC	
EKPBM-RGB03	Pushbutton Spring Return type Red head Gray/Black base 3NC	
EKPBM-YGB03	Pushbutton Spring Return type Yellow head Gray/Black base 3NC	
EKPBM-GGB03	Pushbutton Spring Return type Green head Gray/Black base 3NC	
 	EKPBM-BYG11	Pushbutton Spring Return type Black head Yellow/Gray base 1NO+1NC
	EKPBM-RYG11	Pushbutton Spring Return type Red head Yellow/Gray base 1NO+1NC
	EKPBM-YYG11	Pushbutton Spring Return type Yellow head Yellow/Gray base 1NO+1NC
	EKPBM-GYG11	Pushbutton Spring Return type Green head Yellow/Gray base 1NO+1NC
	EKPBM-BYG20	Pushbutton Spring Return type Black head Yellow/Gray base 2NO
	EKPBM-RYG20	Pushbutton Spring Return type Red head Yellow/Gray base 2NO
	EKPBM-YYG20	Pushbutton Spring Return type Yellow head Yellow/Gray base 2NO
	EKPBM-GYG20	Pushbutton Spring Return type Green head Yellow/Gray base 2NO
	EKPBM-BYG02	Pushbutton Spring Return type Black head Yellow/Gray base 2NC
	EKPBM-RYG02	Pushbutton Spring Return type Red head Yellow/Gray base 2NC
	EKPBM-YYG02	Pushbutton Spring Return type Yellow head Yellow/Gray base 2NC
	EKPBM-GYG02	Pushbutton Spring Return type Green head Yellow/Gray base 2NC
	EKPBM-BYG21	Pushbutton Spring Return type Black head Yellow/Gray base 2NO+1NC
	EKPBM-RYG21	Pushbutton Spring Return type Red head Yellow/Gray base 2NO+1NC
	EKPBM-YYG21	Pushbutton Spring Return type Yellow head Yellow/Gray base 2NO+1NC
	EKPBM-GYG21	Pushbutton Spring Return type Green head Yellow/Gray base 2NO+1NC
	EKPBM-BYG12	Pushbutton Spring Return type Black head Yellow/Gray base 2NC+1NO
	EKPBM-RYG12	Pushbutton Spring Return type Red head Yellow/Gray base 2NC+1NO
	EKPBM-YYG12	Pushbutton Spring Return type Yellow head Yellow/Gray base 2NC+1NO
	EKPBM-GYG12	Pushbutton Spring Return type Green head Yellow/Gray base 2NC+1NO
	EKPBM-BYG30	Pushbutton Spring Return type Black head Yellow/Gray base 3NO
EKPBM-RYG30	Pushbutton Spring Return type Red head Yellow/Gray base 3NO	
EKPBM-YYG30	Pushbutton Spring Return type Yellow head Yellow/Gray base 3NO	
EKPBM-GYG30	Pushbutton Spring Return type Green head Yellow/Gray base 3NO	
EKPBM-BYG03	Pushbutton Spring Return type Black head Yellow/Gray base 3NC	
EKPBM-RYG03	Pushbutton Spring Return type Red head Yellow/Gray base 3NC	
EKPBM-YYG03	Pushbutton Spring Return type Yellow head Yellow/Gray base 3NC	
EKPBM-GYG03	Pushbutton Spring Return type Green head Yellow/Gray base 3NC	
 	EKPBM-RYB01	Pushbutton Locking press-button type Red head Yellow/Black base 1NC
	EKPBM-RYB11	Pushbutton Locking press-button type Red head Yellow/Black base NO+NC
	EKPBM-RYB10	Pushbutton Locking press-button type Red head Yellow/Black base 1NO

Plastic Type	Description	Type	Scheme	Marking on legend	Marking push button	
	1 green flush pushbutton spring return	EKCB-B101H29	NO	Start	●	
		EKCB-B102		—	ⓘ	
		EKCB-B103		—	—	●
		EKCB-B101		—	—	●
	1 red protecting pushbutton spring return marked	EKCB-B112	NC	—	⓪	
	1 Selector switch 2-positions stay put Standard black handle	EKCB-B132H29	NO	Start Stop	⊕	
		EKCB-B134H29	NO	⊖	⊕	
	1 red mushroom head button, φ40mm, latching Turn to release	EKCB-J174		—	⓪	
		EKCB-J174H29	NC	Emergency Stop	⓪	
	1 red mushroom head button, φ40mm, latching Turn to release cover with lock	EKCB-P174	NC	— Emergency Stop	⓪ ⓪	
	1 red mushroom head button, φ40mm, latching Key release (Key n°445) IP40/65	EKCB-J184	NC	—	●	
		EKCB-J184H29		Emergency Stop	●	

Plastic Type	Description	Type	Scheme	Marking on legend	Marking push button	
	2 spring return push button 1 flush green 1 flush red	EKCB-B211H29	NO		Stop Start	
		EKCB-B213	+		—	
		EKCB-B215	NC		—	
	2 spring return pushbutton 1 flush white (black arrow) 1 flush black (white arrow)	EKCB-B222	NO		—	
		EKCB-B223	NC		—	
	2 spring return push button 2 flush green 1 flush red	EKCB-B361H29	NO + NC + NO	  	Start Stop Start	
	1 red pilot light, Directly supply ≤130★ Bulb not supplied+ 2 spring return pushbuttons 1 flush green 1 flush red	EKCB-B363	LED		—	
		EKCB-B363H29	NC + NO	 	Start Stop	
	3 spring return pushbutton 1 flush white (black arrow) 1 flush red 1 flush black (white arrow)	EKCB-B324	NO		—	
		EKCB-B334	NC + NO	 	—	
	2 spring return pushbutton + 1 Mushroom button	EKCB-B339	NO		—	
		EKCB-B393	NC + NO	 	— — —	



Product Overview

EKCB push button enclosures are designed for 22mm diameter pushbuttons, switches, and pilot lights. These enclosures help protect push button operators from damage and wear, thereby preserving the integrity of sensitive electrical contacts.

- Type: 1 hole to 5 holes, 60mm and 73mm height available.
- ABS non-flame-retardant materials. (self-extinguishing material can be customized)
- EN60529 IP65 protection grade.
- Colors: Grey box; Yellow or White cover.
- Threaded cable entry with membrane conduit knock: PG13.5 or M20 glands.
- Temperature range: -40°C to +100°C

Description

Type	Cover Colour	Model	Description
1 Hole	White	EKCB-A1W	IP65 Pushbutton Enclosure, 1 Hole, Plastic, White, 22mm Cut Out, Height 60mm
	Yellow	EKCB-A1Y	IP65 Pushbutton Enclosure, 1 Hole, Plastic, Yellow, 22mm Cut Out, Height 60mm
2 Hole	White	EKCB-A2W	IP65 Pushbutton Enclosure, 2 Hole, Plastic, White, 22mm Cut Out, Height 60mm
	Yellow	EKCB-A2Y	IP65 Pushbutton Enclosure, 2 Hole, Plastic, Yellow, 22mm Cut Out, Height 60mm
3 Hole	White	EKCB-A3W	IP65 Pushbutton Enclosure, 3 Hole, Plastic, White, 22mm Cut Out, Height 60mm
	Yellow	EKCB-A3Y	IP65 Pushbutton Enclosure, 3 Hole, Plastic, Yellow, 22mm Cut Out, Height 60mm
4 Hole	White	EKCB-A4W	IP65 Pushbutton Enclosure, 4 Hole, Plastic, White, 22mm Cut Out, Height 60mm
	Yellow	EKCB-A4Y	IP65 Pushbutton Enclosure, 4 Hole, Plastic, Yellow, 22mm Cut Out, Height 60mm
5 Hole	White	EKCB-A5W	IP65 Pushbutton Enclosure, 5 Hole, Plastic, White, 22mm Cut Out, Height 60mm
	Yellow	EKCB-A5Y	IP65 Pushbutton Enclosure, 5 Hole, Plastic, Yellow, 22mm Cut Out, Height 60mm

Push Button Station Enclosure Ø22mm

Type	Cover Colour	Model	Description
1 Hole	White	EKCB-B1W	IP65 Pushbutton Enclosure, 1 Hole, Plastic, White, 22mm Cut Out, Height 73mm
	Yellow	EKCB-B1Y	IP65 Pushbutton Enclosure, 1 Hole, Plastic, Yellow, 22mm Cut Out, Height 73mm
2 Hole	White	EKCB-B2W	IP65 Pushbutton Enclosure, 2 Hole, Plastic, White, 22mm Cut Out, Height 73mm
	Yellow	EKCB-B2Y	IP65 Pushbutton Enclosure, 2 Hole, Plastic, Yellow, 22mm Cut Out, Height 73mm
3 Hole	White	EKCB-B3W	IP65 Pushbutton Enclosure, 3 Hole, Plastic, White, 22mm Cut Out, Height 73mm
	Yellow	EKCB-B3Y	IP65 Pushbutton Enclosure, 3 Hole, Plastic, Yellow, 22mm Cut Out, Height 73mm
4 Hole	White	EKCB-B4W	IP65 Pushbutton Enclosure, 4 Hole, Plastic, White, 22mm Cut Out, Height 73mm
	Yellow	EKCB-B4Y	IP65 Pushbutton Enclosure, 4 Hole, Plastic, Yellow, 22mm Cut Out, Height 73mm
5 Hole	White	EKCB-B5W	IP65 Pushbutton Enclosure, 5 Hole, Plastic, White, 22mm Cut Out, Height 73mm
	Yellow	EKCB-B5Y	IP65 Pushbutton Enclosure, 5 Hole, Plastic, Yellow, 22mm Cut Out, Height 73mm

Dimension(mm)

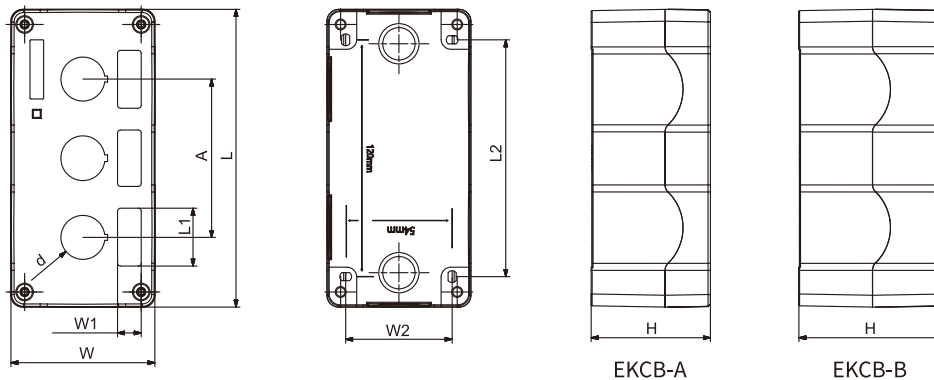

Model	L	W	H	L1	W1	L2	W2	A	d
EKCB-A1	73	73	60	29	12	40	54	-	Ø22
EKCB-A2	111	73	60	29	12	80	54	40	Ø22
EKCB-A3	151	73	60	29	12	120	54	80	Ø22
EKCB-A4	191	73	60	29	12	160	54	120	Ø22
EKCB-A5	231	73	60	29	12	200	54	160	Ø22
EKCB-B1	73	73	73	29	12	40	54	-	Ø22
EKCB-B2	111	73	73	29	12	80	54	40	Ø22
EKCB-B3	151	73	73	29	12	120	54	80	Ø22
EKCB-B4	191	73	73	29	12	160	54	120	Ø22
EKCB-B5	231	73	73	29	12	200	54	160	Ø22



Introduction

The EKRS series rotary switch mainly applies to 440V and below, AC 50Hz or 240V and below DC circuits. For breaking and closing, change-over of circuits under unfrequently manual operation. And the typical application are: control switch of 3 phase motors, control switch of switch gear, control switch of instruments, and change-over switch of machinery and welding machine.

- The series comply with the IEC 60947-3, IEC 60947-5-1.
- The EKRS26 series have 8 current ratings: 10A,20A,25A,32A,63A,125A ,160A and 315A.
- The EKRS26 series rotary switch were designed for multiple functions, wide variety of applications.
- The EKRS26-10, EKRS26-20, EKRS26-25, and EKRS26-32F have finger protection terminals.
- Both of them are applicable in circuits when an physical control is required.
- We can equip protective box for 20A, 25A, 32A and 63A.

Working conditions

- Ambient temperature do not exceed 40°C, and the average temperature, measured over a period of 24 hours, do not exceed 35°C
- Ambient temperature should not be below -25°C
- Should Not be installed over 2000m above sea level
- The humidity should not exceed 50% when the ambient temperature is 40°C and higher humidity is allowed for lower temperature

Installation conditions

- A clean environments is required
- Please follow our manual

Type Designation

Use as control switches

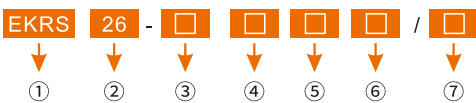

①	Rotary switch (Cam switch)
②	Product code
③	Rated thermal current
④	Code of the degree of rotation
⑤	Character code
⑥	Code for contact diagram of the switch
⑦	Number of layers

Re: Character code represent the rotating type, for instance, we have limited movement, spring return and limited movement with spring return. Code of the degree of rotation: 30°(3); 45°(4); 60°(6); 90°(9). 30°spring return, 60°limited movement(36);30°spring return, 90°limited movement(39).

Use as motor switches

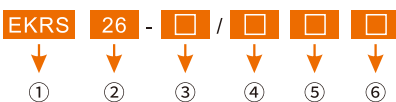

①	Rotary switch (Cam switch)
②	Product code
③	Rated thermal current
④	Rated power of motor(3 phase AC)
⑤	Usage Code
⑥	Number of layers

Re1: usage code (1) Q for start and run (2) N for start and reversing (3) S start and run at 2speed (4)SN for start and reversing of 2 speed motor (5)M16 for start and reversing of 3 speed motor
Re2:switches in this category normally rotated at 60°or 90°. And the SN normally rotated at 45°.

Use as control switch for a main circuit

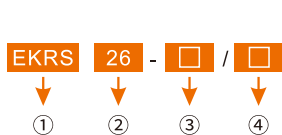

①	Rotary switch (Cam switch)
②	Product code
③	Rated working current
④	Number of poles: 2 poles(2). 3 poles(3), and 4 poles(4)

Re: switches in this category normally rotated at 60° or 90°

Classification

1. Classified by utilization

- Change-over switch
- Motor switch
- Control switch

2. Classified by operation

- Limited movement
- Spring return
- Limited movement with spring return

3. Classified by contact system

- Switches with limited movement could have 12 layers in maximum (for 32 A and below). And for 63 A and above could have 8 layers in maximum
- Switches with spring return could have 3 layers in maximum
- Motor switches could have 6 layers in maximum

4. Diagram for the operation and position of handle

Operation angle	Character code	Position of handle			
		30° Rotation	45° Rotation	60° Rotation	90° Rotation
Spring return	A	0° ← 30°	0° ← 45°	0° ← 60°	0° ← 90°
	B	30° → 0° ← 30°	45° → 0° ← 45°	60° → 0° ← 60°	90° → 0° ← 90°
	X	60° → 30° → 0° ← 30° ← 60°	90° → 45° → 0° ← 45° ← 90°		
	Y	90° → 60° → 30° → 0° ← 30° ← 60° ← 90°			
Limited movement	C	0° 30°	0° 45°	0° 60°	
	D	30° 0° 30°	45° 0° 45°	60° 0° 60°	
	E	30° 0° 30° 60°	45° 0° 45° 90°	60° 0° 60° 120°	
	F	60° 30° 0° 30° 60°	90° 45° 0° 45° 90°	60° 0° 60° 120°	
	G	60° 30° 0° 30° 60° 90°	90° 45° 0° 45° 90° 135°	120° 60° 0° 60° 120° 180°	
	H	90° 60° 30° 0° 30° 60° 90°	135° 90° 45° 0° 45° 90° 135°		
	I	90° 60° 30° 0° 30° 60° 90° 120°	135° 90° 45° 0° 45° 90° 135° 180°		
	J	120° 90° 60° 30° 0° 30° 60° 90° 120°			
	K	20° 90° 60° 30° 0° 30° 60° 90° 120° 150°			
	L	150° 120° 90° 60° 30° 0° 30° 60° 90° 120° 150°			
	M	150° 120° 90° 60° 30° 0° 30° 60° 90° 120° 150° 180°			
	N		45° 45°	30° 30°	
Limited movement with spring return	P				90° 0° 90°
	T				0° 90°
	V				90° 0°
	R				270° 0° 90° 180°
	Q	30° 0° ← 30°	135° 90° 45° 0° ← 45°		
	S	30° → 0° 60°	135° 90° 45° 0° ← 45°		
Limited movement with spring return	W		90° → 45° 0° 45° ← 90°		
	Z	30° → 90° 0° ← 30°	135° → 90° 0° ← 45°		

Escutcheon plate and Handle

Escutcheon plate Type pf Handle

Type of handle	Color	Escutcheon plate					Type of handle	Color	Escutcheon plate				
		M0	M1	M2	M3	M4			M0	M1	M2	M3	M4
 R Type	Black		●	●	●		 I Type	Black	●	●	●	●	●
	Red			●	●			Red		●	●		
	White							White					
	Gray							Gray					
	Yellow							Yellow		●			
 R2 Type	Black		●	●			 B Type	Black		●	●		
	Red							Red		●			
	White							White			●		
	Gray							Gray					
	Yellow							Yellow					
 F type	Black	●	●	●			 L Type	Black			●		
	Red							Red					
	White							White					
	Gray							Gray					
	Yellow							Yellow					
 H Type	Black			●			 O Type	Black			●		
	Red							Red					
	White							White					
	Gray							Gray					
	Yellow							Yellow					
 P Type	Black			●	●	●	 K Type	Black			●	●	
	Red							Red					
	White							White					
	Gray							Gray					
	Yellow							Yellow					

Re: ● Standard ● Optional

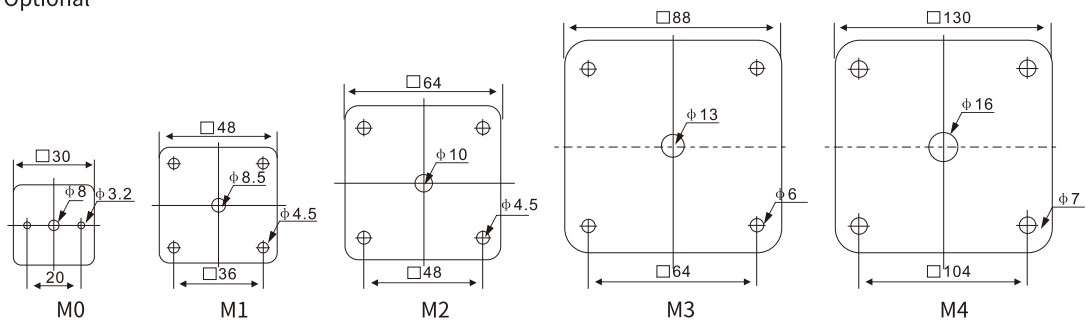

Description	Escutcheon plate						Type of handle								Rotating angle				Maximum Number of Layers					
	M0	M1	M1B	M2	M2B	M3	R	R2	F	I	R	H	I	O	P	K	30°	45°	60°	90°	12	10	8	
EKRS26-10	●								●	●							●	●	●	●		●		
EKRS26-20		●	●	●	●		●	●	●	●	●	●	●	●	●	●	●	●	●	●	●	●		
EKRS26-25		●	●	●	●		●	●	●	●	●	●	●	●	●	●	●	●	●	●	●	●		
EKRS26-32				●	●	●	●	●	●	●	●	●	●	●	●	●	●	●	●	●	●	●		
EKRS26-63				●	●	●	●	●	●	●	●	●	●	●	●	●	●	●	●	●	●	●		●
EKRS26-125						●	●							●	●		●	●	●	●			●	●
EKRS26-160						●	●							●	●		●	●	●	●			●	●
EKRS26-315									●					●										

Re: M1B M2B Plate should be installed by self tapping screw



Dimensions and Installation

Square Escutcheon Plate and Rectangular Escutcheon Plate

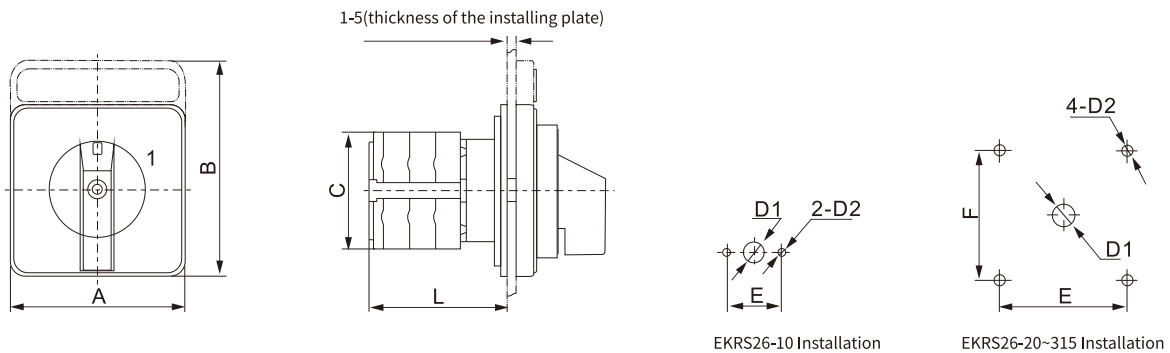

Description	Escutcheon plate	Dimensions(mm)				Installation(mm)			
		A	B	C	L	E	F	D1	D2
EKRS26-10	M0 square	30	30	28	22+8n	20		φ8	φ3.2
EKRS26-20	M1 square	48	48	43	22+9.6n	36	36	φ8.5	φ4.5
	M1 rectangular	48	60	43	22+9.6n	36	36	φ8.5	φ4.5
	M2 square	64	64	43	25+9.6n	48	48	φ10	φ4.5
	M2 rectangular	64	80	34	25+9.6n	48	48	φ10	φ4.5
	M3 square	88	88	43	25+9.6n	48	48	φ10	φ4.5
EKRS26-25	M1 square	48	48	45.2	23+12.8n	36	36	φ8.5	φ4.5
	M1 rectangular	48	60	45.2	23+12.8n	36	36	φ8.5	φ4.5
	M2 square	64	64	45.2	26.5+12.8n	48	48	φ10	φ4.5
EKRS26-32	M2 rectangular	64	88	45.2	26.5+12.8n	48	48	φ10	φ4.5
	M2 square	64	64	58	29.2+12.8n	48	48	φ10	φ4.5
	M3 square	88	88	58	29.2+12.8n	68	68	φ13	φ6
EKRS26-63	M2 square	64	64	66	29.2+21.5n	48	48	φ10	φ4.5
	M2 rectangular	64	80	66	29.2+21.5n	48	48	φ10	φ4.5
	M3 square	88	88	66	29.2+21.5n	68	68	φ13	φ6
EKRS26-125	M3 square	88	88	84	35+26.5n	68	68	φ13	φ6
EKRS26-160	M3 square	88	88	88	35+32.5n	68	68	φ13	φ6
EKRS26-315	M4 square	130	130	126	39.5+38.5n	104	104	φ16	φ7

Re: n for number of layers

Technical Parameters

Description		EKRS26-10		EKRS26-20		EKRS26-25		EKRS26-32		EKRS2626-63		EKRS26-125		EKRS26-160		EKRS26-315	
Rated insulation voltage U_i V		660		660		660		660		660		660		660		660	
Rated thermal current I_{th} A		10		20		25		32		63		125		160		315	
Rated working voltage U_e V		240	440	240	440	240	440	240	440	240	440	240	440	240	440	240	440
Rated working current I_e																	
AC-21A AC-22A	A	10	10	20	20	25	25	32	32	63	63	100	100	150	150	315	315
AC-23A	A	7.5	7.5	15	15	22	22	30	30	57	57	90	90	135	135	265	265
AC-2	A	7.5	7.5	15	15	22	22	30	30	57	57	90	90	135	135	265	265
AC-3	A	5.5	5.5	11	11	15	15	22	22	36	36	75	75	95	95	110	110
AC-4	A	1.75	1.75	3.5	3.5	6.5	6.5	11	11	15	15	30	30	55	55	95	95
AC-15	A	2.5	1.5	5	4	8	5	14	6								
AC-13	A			0.4		0.5											
Power	P																
AC-23A	KW	1.8	3	3.7/2.5	7.5/3.7	5.5/3	11/5.5	7.5/4	1.5/7.5	15/10	30/18.5	30/15	45/22	37/22	75/37	75/37	132/55
AC-2	KW	2.5	3.7	4	7.5	5.5	11	7.5	15	18.5	30	30	45	37	55	55	95
AC-3	KW	1.5	2.2	3/2.2	5.5/3	4/3	7.5/3.7	5.5/4	11/5.5	11/6	18.5/11	15/7.5	30/13	22/11	37/18.5	27/22	55/30
AC-4	KW	0.37	0.55	0.55/0.75	1.5/1.5	1.5/1.1	3/2.2	2.7/1.5	5.5/3	5.5/2.4	7.5/4	6/3	12/5.5	10/4	15/7.5	15/7.5	25/11

Re1: Neutral

Re2: The power under :

AC-23A, AC-3, AC-4 are in three phase three pole, and the denominator represents the power under single phase two poles

Mechanical life

Mechanical life without load : 0.1×10^6 times , operation frequency is 120 times/h.

Mechanical life with load : 0.03×10^6 times, operation frequency is 120 times/h.

Customized Programme form(CPF)

Due to the flexibility selection of EKRS series contact ratings and number of contacts etc, their combination number is almost limitless, to ensure that a right switch is chosen for the application, so -we prepare the following Customized programme Form for our customers order special switches.

Only EKRS26 series.

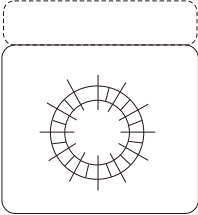
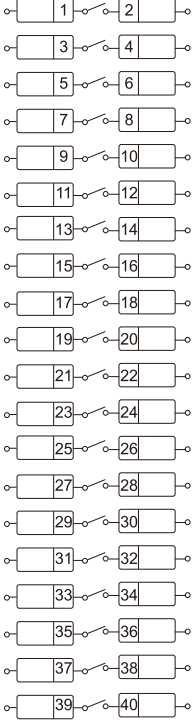
 <p>Switching Angle: Switching Position: Escutcheon Size:</p>	Customer: _____ Date: _____	
	Porgramme code: _____ Quantlty: _____	
	Utilization Category: _____	
	Switch Type: Handle Code:	Mounting: Handle Colour:
<input type="checkbox"/> <input type="checkbox"/> <input type="checkbox"/> <input type="checkbox"/> <input type="checkbox"/>	Panel type: <input type="checkbox"/> M0 <input type="checkbox"/> M1 <input type="checkbox"/> M2 <input type="checkbox"/> M3 <input type="checkbox"/> M4	
Thermal Current Rating: <input type="checkbox"/> 10A <input type="checkbox"/> 20A <input type="checkbox"/> 25A <input type="checkbox"/> 32A <input type="checkbox"/> 63A <input type="checkbox"/> 125A <input type="checkbox"/> 160A <input type="checkbox"/> 315A		
		
Note:		

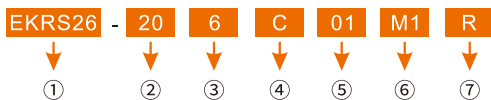

- ① The type of switch
- ② Rated Thermal Current. For example: 20A
- ③ Rotary angle. For example: 60° 30°(3); 45°(4); 60°(6); 90°(9).
- ④ Character code. For example: C
- ⑤ Contact diagram code. For example: 5391
- ⑥ Plate type. For example: M1
- ⑦ Handle type. For example: R

General Panel Diagram

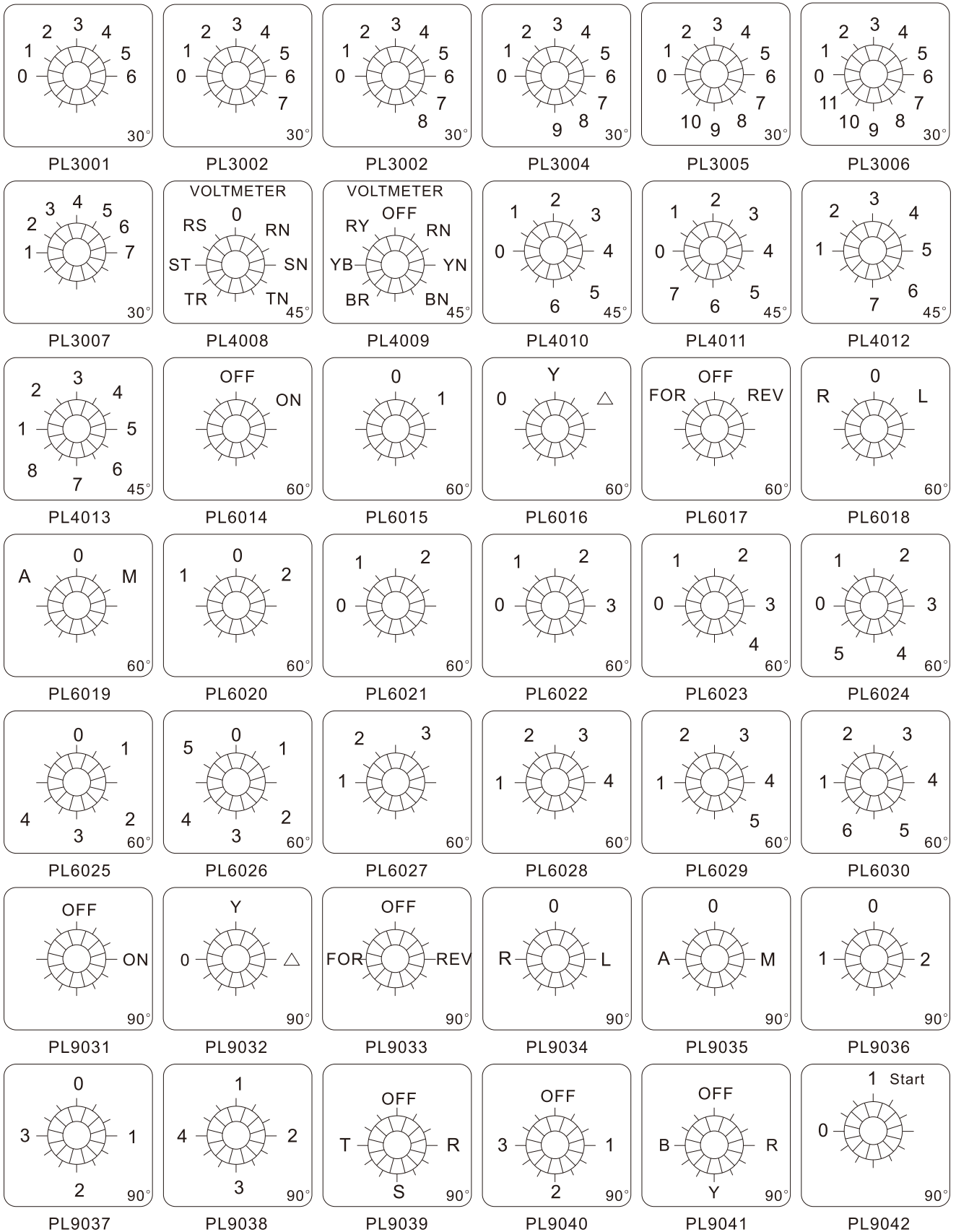

General Panel Diagram

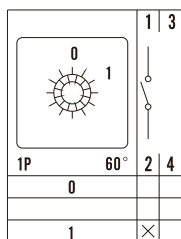

01

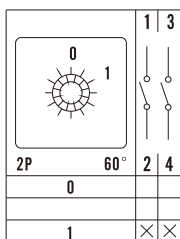

02

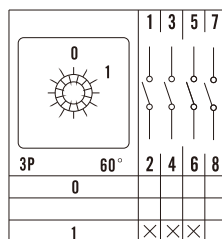

03

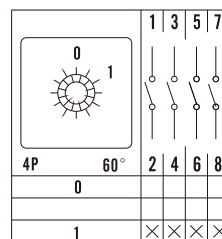

04

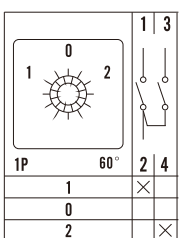

101

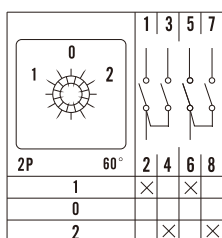

202

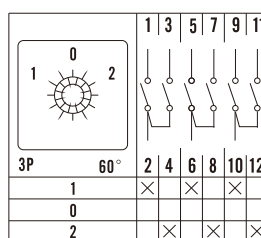

303

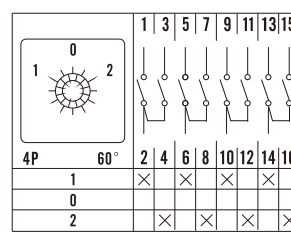

404

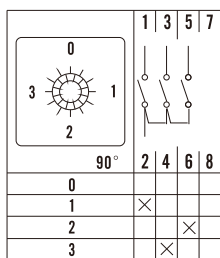

0111

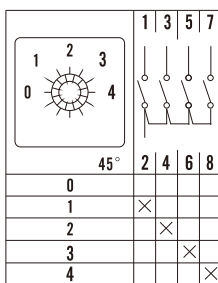

01111

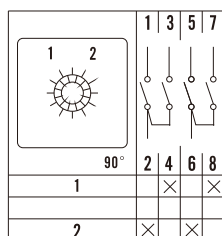

22

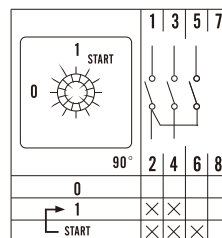

023

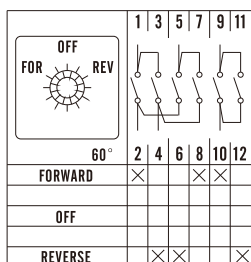

N

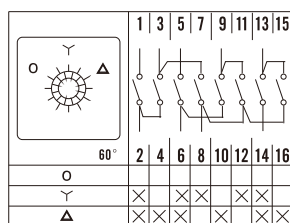

M07

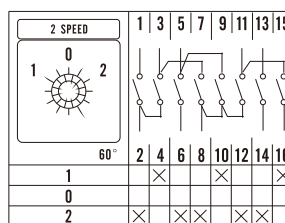

S1

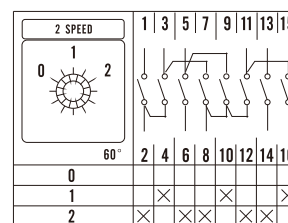

S2

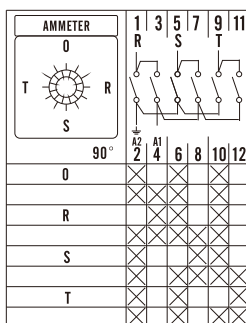

LH3

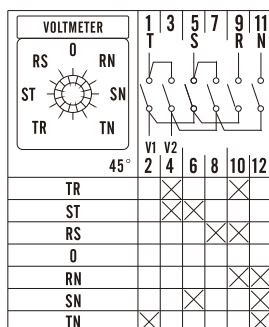

YH5

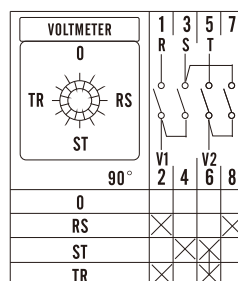

YH2

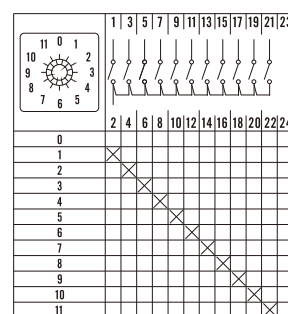

M6886



EKIS30-32/3/GS03-2

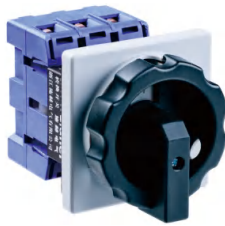

EKIS30-32/3/GSB3



EKIS30-32/3/GFB



EKIS30A-25/4/GSB4



EKIS30-32/3/D2(150)

Product Overview

EKIS30 series rotary switch is mainly used in electrical circuits with AC 50Hz, rated operating voltage below 440V, and rated current up to 100A. It is used as the main switch for ventilation equipment, air conditioning and water pump systems. It can also directly control small-capacity AC motors.

The product complies with standard IEC60947-3.

EKIS30 series switches have complete specifications, including current levels of 20A, 25A, 32A, 40A, 63A, 80A, 100A and 125A.

EKIS30 series parallel switch has small size, compact structure, exquisite material selection, good insulation, finger protection function, safety and reliability. Other contact blocks can be added to the 3-pole standard block without dismantling the switch.

The insulation distance of EKIS30 series switches is larger than other switches of the same type, the disconnection speed is fast, and it is suitable for DC switches.

Type Designation



Code	Meaning
①	Company code
②	Rotary switch (Isolation switch)
③	Design sequence NO.
④	Rated thermal current

Code	Meaning
⑤	Section number
⑥	N or N11
⑦	Installation method
⑧	Handle

Operating and Installation Conditions

Pollution level	3
Protection degree	Without switch box: IP20; With thermoplastic sealed switch box: IP65
Ambient temperature	-25°C~+40°C, the average no more than +35°C within 24 hours.
Altitude	≤2000m
Ambient humidity	The maximum temperature of 40°C, the air relative humidity not exceed 50%, under lower temperature can allow for higher relative humidity. If the temperature is 20°C, the air relative humidity could up to 90%, Special measures should be taken for occasional condensation due to humidity changes.
Installation position	Install according to the instructions provided by the factory.

Technical Data

Model	EKIS30-25(20)	EKIS30-32	EKIS30-40	EKIS30-63	EKIS30-80	EKIS30-100	EKIS30-125	
Rated thermal current(I _{th})(V)	25(20)	32	40	63	80	100	125	
Rated working voltage(U _e)(A)	240/440							
Usage categories	AC-23A, AC-3							
Rated value I _e /kw	AC-21A	20/- 20/-	32/- 32/-	40/- 40/-	63/- 63/-	80/- 80/-	100/- 100/-	125/- 125/-
	AC-22A	20/- 20/-	32/- 32/-	40/- 40/-	63/- 63/-	80/- 80/-	100/- 100/-	125/- 125/-
	AC-23A	15/4 15/7.5	22/5.5 22/11	30/7.5 30/15	43/11 43/22	57/18.5 57/30	70/22 70/37	90/30 90/45
	AC-3	11.7/3 11.7/5.5	15/4 15/7.5	22/7.5 22/11	36/11 36/18.5	43/15 43/22	57/18.5 57/30	70/22 70/37
Current type	AC 50Hz							
Number of main contact	ON or OFF two positions							
Rated working system	8-hour working system/intermittent cycle working system, operating frequency is 30 times/h							
Electrical life	AC-23: 10000 times; AC-3: 6000 times; Auxiliary contacts: 2000 times							

Dimension(mm)

Panel installation

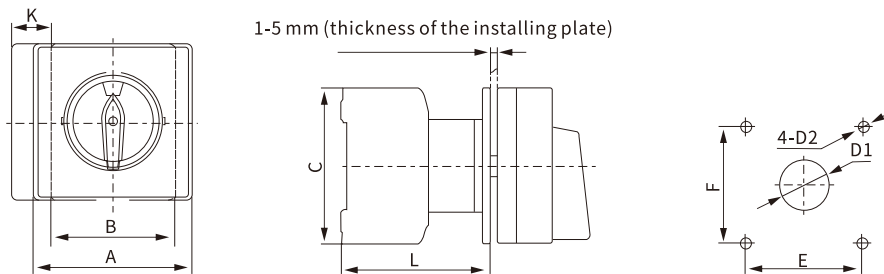

Model	Dimensions					Installation			
	A	B	C	K	L	E	F	D1	D2
EKIS30-25/32	64	43	54	13.5	61	48	48	Ø10	Ø4.5
EKIS30-40/63	64	50	64	16	67	48	48	Ø10	Ø4.5
EKIS30-80/100	64	70	80	22	82	48	48	Ø10	Ø4.5

Installation of doorlock safety switch

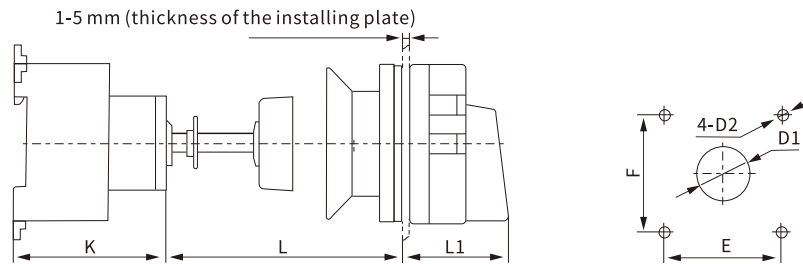

Model	Dimensions			Installation			
	K	L1	L	E	F	D1	D2
EKIS30-20	50	32	150	48	48	Ø22	Ø4.5
EKIS30-25	50	32	150	48	48	Ø22	Ø4.5
EKIS30-32	50	32	150	48	48	Ø22	Ø4.5
EKIS30-40	61	32	150	48	48	Ø22	Ø4.5
EKIS30-63	61	32	150	48	48	Ø22	Ø4.5
EKIS30-80	68	32	150	48	48	Ø22	Ø4.5
EKIS30-100	68	32	150	48	48	Ø22	Ø4.5

Single hole installation

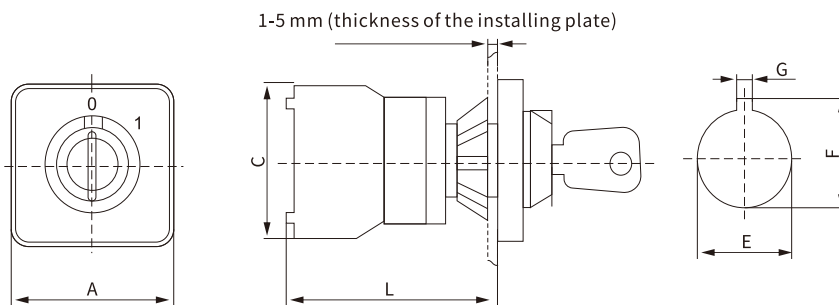

Model	Dimensions			Installation		
	A	C	L	E	F	G
EKIS30-20/25	49	54	73	Ø22.5	24.1	3.2
EKIS30-32	49	54	73	Ø22.5	24.1	3.2
EKIS30-20/25	62	54	73	Ø22.5	24.1	3.2
EKIS30-32	62	54	73	Ø22.5	24.1	3.2



EKIS30-32/3/H1/GSB



EKIS30-63/3/H3/GSB



EKIS30-100/3/H5/GSB

Type Designation



Code	Meaning
①	Company code
②	Isolation switch waterproof box
③	Rated current

Code	Meaning
④	Number of poles
⑤	Waterproof box type and size
⑥	Switch handle: GSB

Dimension(mm)

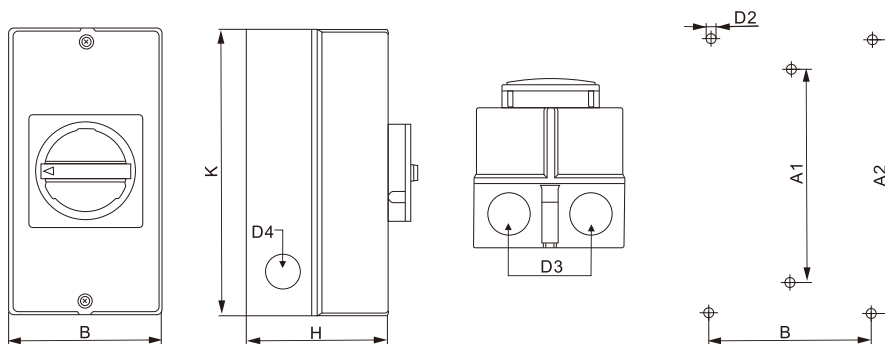

Model	Dimensions					Installation			
	D3	D4	H	B	K	A1	A2	B	D2
EKIS30-20/25/32	Ø23	Ø19	82	85	160	150	-	-	Ø4.2
EKIS30-40/63	Ø29	Ø23	93	100	190	178	-	-	Ø4.2
EKIS30-80/100/125	Ø37.5	Ø23	107	145	250	-	229	124	Ø6.5



EKISP0-20/3/L0/GSC



EKISP1-25/3/L1/GSC



EKISP3-63/3/L3/GSC



EKISP5-100/3/L5/GSC

Type Designation



Code	Meaning
①	Company code
②	Isolation switch waterproof box
③	Rated current

Code	Meaning
④	Number of poles
⑤	Waterproof box type and size
⑥	Switch handle: GSC

Dimension(mm)

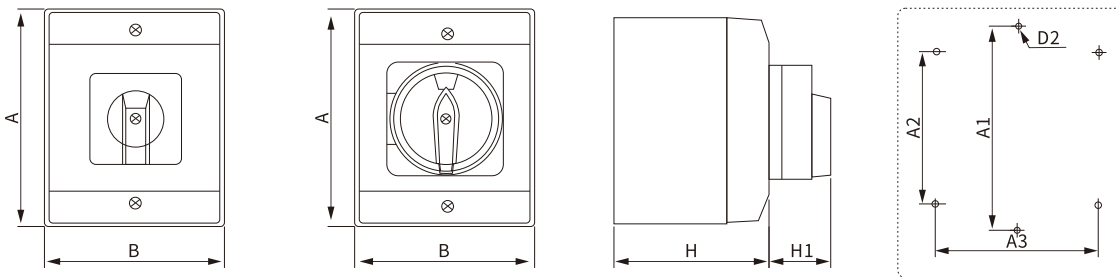

Model	Dimensions				Installation			
	A	B	H	H1	D2	A1	A2	A3
EKISP-16/20	100	80	65	35	Ø4.5	92	60	60
EKISP-25/32	125	100	85	35	Ø4.5	115	80	80
EKISP-40/63	175	115	100	35	Ø4.5	165	90	90
EKISP-80/100/125	240	160	85	35	Ø4.5	-	193	142

Notes

A series of horizontal dashed lines for writing notes.

 The product data referred to in the company shall be subject to material object. Subject to change without notice.
The company has the final right to interpret.

 Green paper printing.

Tel-
0086-577-62780116

Fax-
0086-577-62774090

Email-
info@etek-china.com

No. 288 Wei 17th Road,
Economic Development Zone,
Yueqing City Zhejiang China.

ETEK[®]
E TEK ELECTRIC

ZHEJIANG ETEK
ELECTRICAL TECHNOLOGY CO.,LTD.

